

Mercedes-Benz Places

BINGHATTI

Discover living in Sensual Purity

New grounds for extraordinary moments

The Mercedes-Benz Pagoda Suite

2 Bedroom



The Mercedes-Benz Pagoda Suite

2 Bedroom Unit

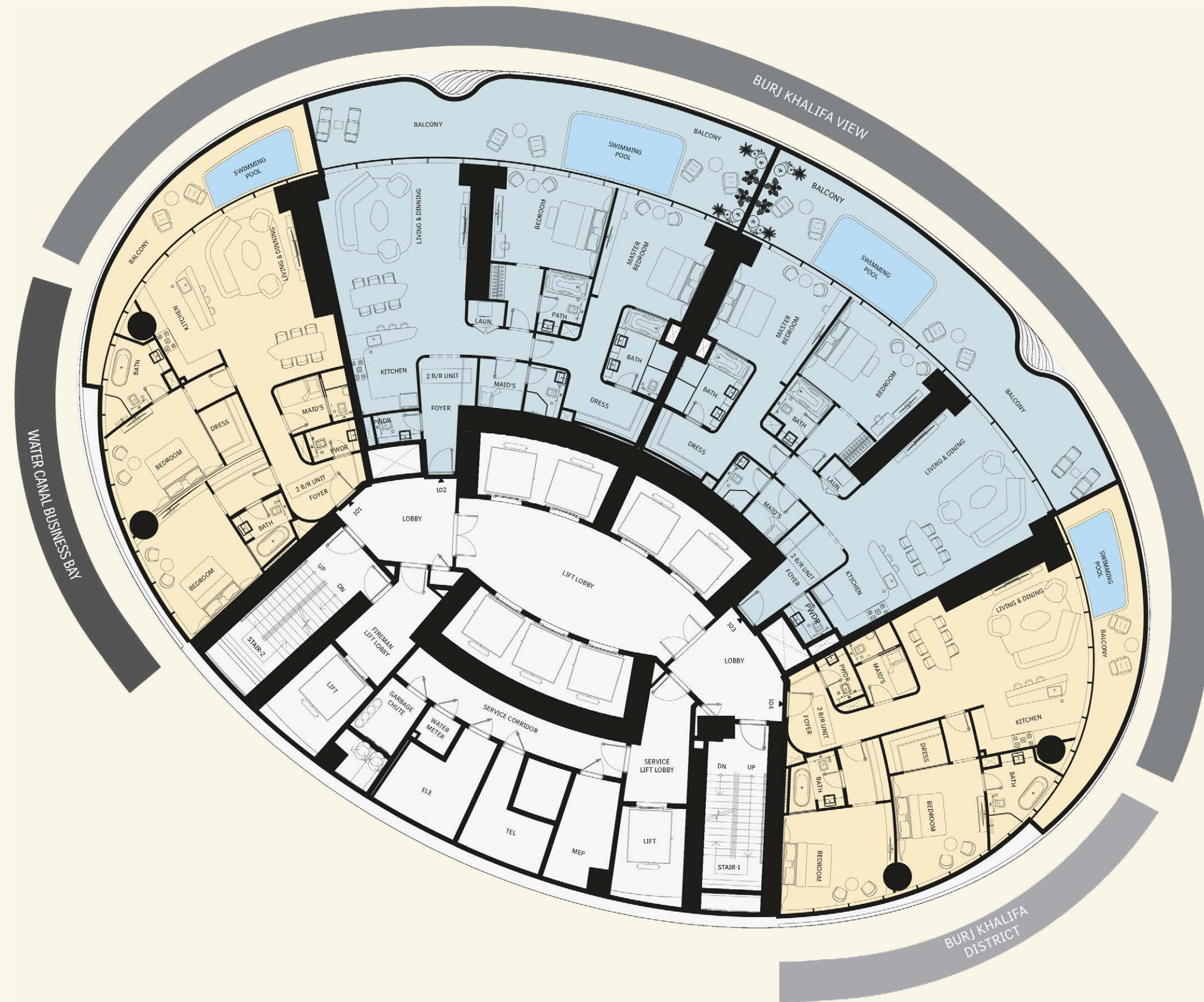

- VIEW ANALYSIS**
- BURJ KHALIFA - BURJ KHALIFA DISTRICT
 - BURJ KHALIFA DISTRICT
 - WATER CANAL - BUSINESS BAY

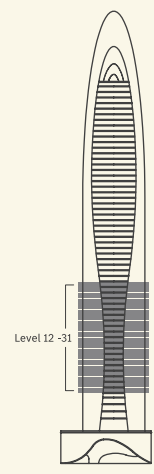

Disclaimer: 1. All stated dimensions and services whether in relation to the building, common areas or individual units are subject to government and local authority approvals. Final dimensions and services will be stated in your sales and purchase agreement 2. All room dimensions are measured to structural elements and exclude wall finishes and construction tolerances. 3. All dimensions have been provided by our consultant architects. 4. All materials, dimensions and drawings are approximate. Information is subject to change without notice. 5. Actual suite area may vary from the stated area. Drawings are not to scale. The Developer reserves the right to make any revisions whatsoever including for aesthetic purposes.

6. Calculation of suite area is measured as the area bounded by the centre line of demising or partition walls separating one unit from another unit, the exterior face of all exterior walls, and the exterior face of the corridor wall enclosing the adjoining unit. 7. Calculation of balcony area is measured as the area bounded by the centre line of demising or partition walls separating one unit from another unit, the outmost face of the enclosing guard and the external face of the adjoining balcony. 8. The units are measured at typical floor in the building. Columns may vary in size depending on the floor level. 9. For each unit type, unit sizes and details might be different and your sales and purchase agreement will contain the actual size of each specific unit.

The Mercedes-Benz Pagoda Suite

2 Bedroom Unit | Type 1-A

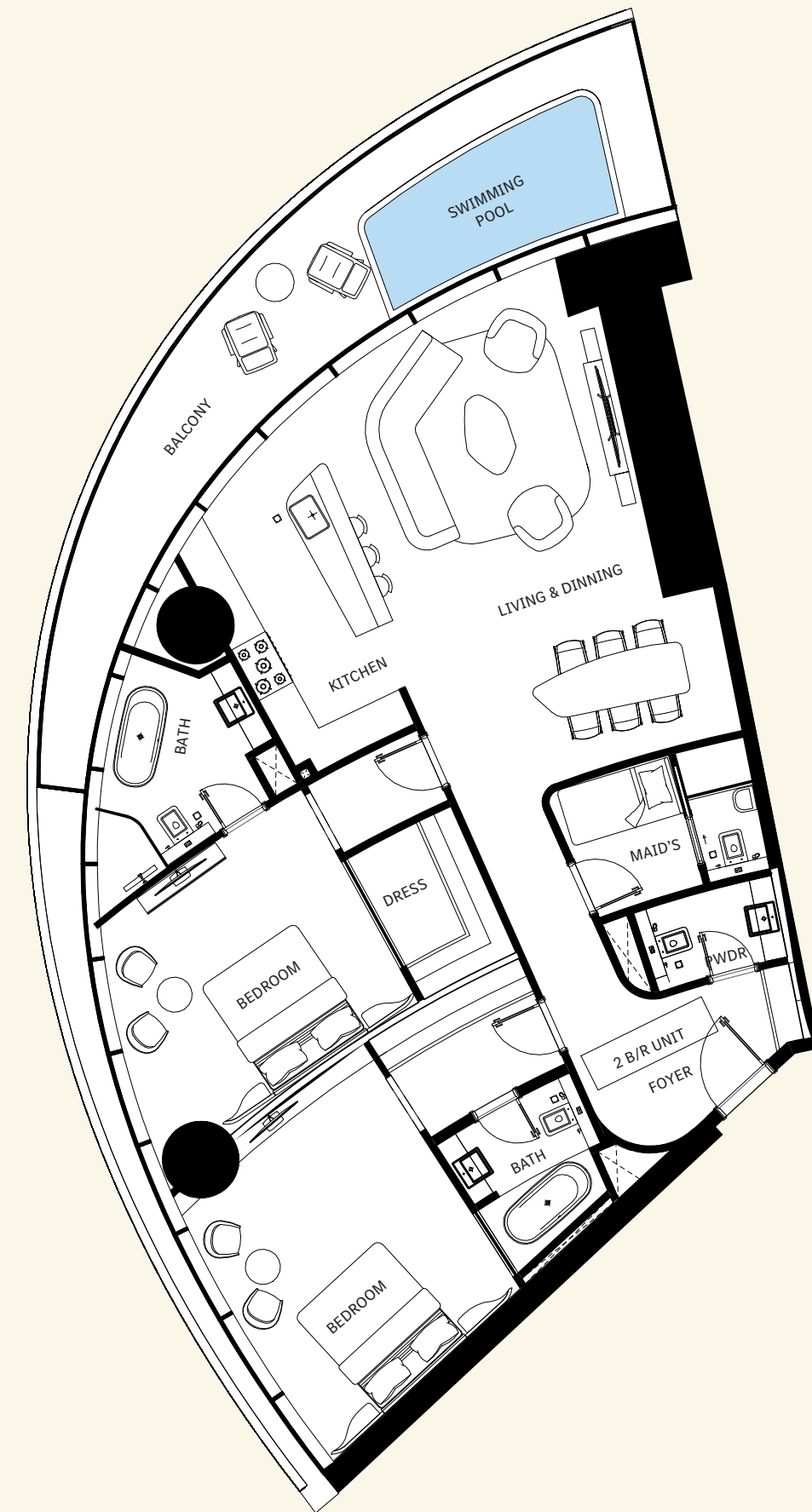

AREA	SQ.M	SQ.FT
Suite Area	142 m ²	1529 ft ²
Balcony Area	29 m ²	308 ft ²
Total Unit Area	171 m ²	1837 ft ²

FLAT DESIGN COMPONENTS	
Living & Dining	37 m ²
Bedroom 1	19 m ²
Bedroom 2	17 m ²
Foyer	11 m ²
Kitchen	11 m ²
Bath 1	8 m ²
Bath 2	5 m ²
Dress 1	5 m ²
Dress 2	4 m ²
Maid	4 m ²
PDWR	3 m ²
Bath	2 m ²
Lobby	2 m ²

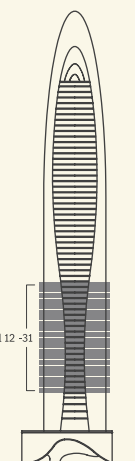

Disclaimer: 1. All stated dimensions and services whether in relation to the building, common areas or individual units are subject to government and local authority approvals. Final dimensions and services will be stated in your sales and purchase agreement 2. All room dimensions are measured to structural elements and exclude wall finishes and construction tolerances. 3. All dimensions have been provided by our consultant architects. 4. All materials, dimensions and drawings are approximate. Information is subject to change without notice. 5. Actual suite area may vary from the stated area. Drawings are not to scale. The Developer reserves the right to make any revisions whatsoever including for aesthetic purposes.

6. Calculation of suite area is measured as the area bounded by the centre line of demising or partition walls separating one unit from another unit, the exterior face of all exterior walls, and the exterior face of the corridor wall enclosing the adjoining unit. 7. Calculation of balcony area is measured as the area bounded by the centre line of demising or partition walls separating one unit from another unit, the outmost face of the enclosing guard and the external face of the adjoining balcony. 8. The units are measured at typical floor in the building. Columns may vary in size depending on the floor level. 9. For each unit type, unit sizes and details might be different and your sales and purchase agreement will contain the actual size of each specific unit.

The Mercedes-Benz Pagoda Suite

2 Bedroom Unit | Type 1
Isometric View



- 1 LIVING LOUNGE
- 2 MASTER BEDROOM
- 3 BEDROOM
- 4 FOYER
- 5 KITCHEN
- 6 BATHROOM SUITE
- 7 BATHROOM SUITE
- 8 WALK-IN CLOSET
- 9 HELPER BEDROOM
- 10 WC
- 11 SWIMMING POOL
- 12 BALCONY

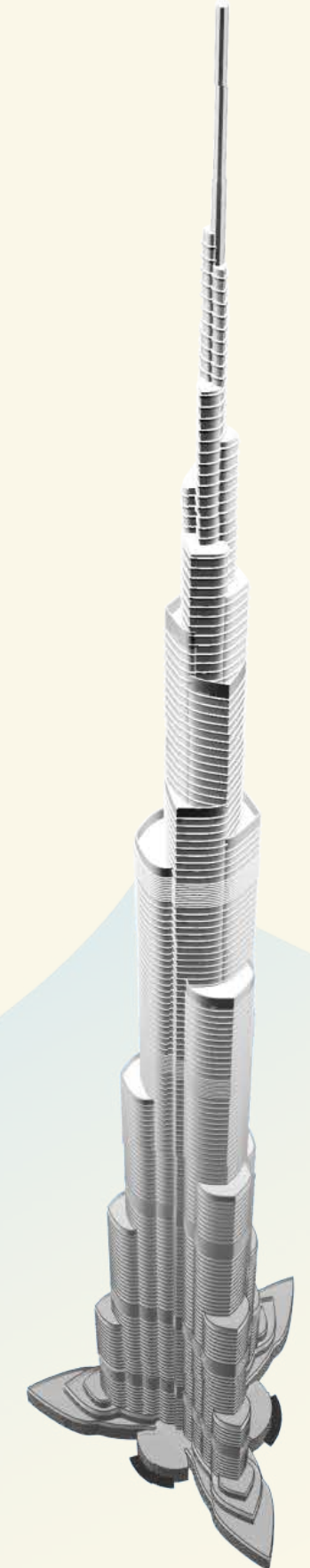

The Mercedes-Benz Pagoda Suite

2 Bedroom Unit | Type 2-A



AREA	SQ.M	SQ.FT
Suite Area	169 m ²	1814 ft ²
Balcony Area	67 m ²	720 ft ²
Total Unit Area	235 m ²	2534 ft ²

FLAT DESIGN COMPONENTS	
Living & Dining	42 m ²
Bedroom 1	20m ²
Bedroom 2	19 m ²
Foyer	9 m ²
Kitchen	10 m ²
Bath 1	8 m ²
Bath 2	4 m ²
Dress 1	7 m ²
Dress 2	5 m ²
Maid	4 m ²
PDWR	2 m ²
Bath	3 m ²
Lobby	3 m ²

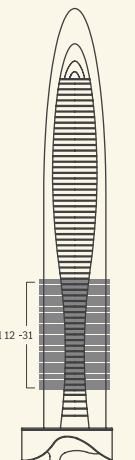

Disclaimer: 1. All stated dimensions and services whether in relation to the building, common areas or individual units are subject to government and local authority approvals. Final dimensions and services will be stated in your sales and purchase agreement 2. All room dimensions are measured to structural elements and exclude wall finishes and construction tolerances. 3. All dimensions have been provided by our consultant architects. 4. All materials, dimensions and drawings are approximate. Information is subject to change without notice. 5. Actual suite area may vary from the stated area. Drawings are not to scale. The Developer reserves the right to make any revisions whatsoever including for aesthetic purposes.

6. Calculation of suite area is measured as the area bounded by the centre line of demising or partition walls separating one unit from another unit, the exterior face of all exterior walls, and the exterior face of the corridor wall enclosing the adjoining unit. 7. Calculation of balcony area is measured as the area bounded by the centre line of demising or partition walls separating one unit from another unit, the outmost face of the enclosing guard and the external face of the adjoining balcony. 8. The units are measured at typical floor in the building. Columns may vary in size depending on the floor level. 9. For each unit type, unit sizes and details might be different and your sales and purchase agreement will contain the actual size of each specific unit.

The Mercedes-Benz Pagoda Suite

2 Bedroom Unit | Type 2
Isometric View



- 1 LIVING LOUNGE
- 2 BEDROOM
- 3 MASTER BEDROOM
- 4 FOYER
- 5 KITCHEN
- 6 BATHROOM SUITE
- 7 BATHROOM SUITE
- 8 WALK-IN CLOSET
- 9 HELPER BEDROOM
- 10 WC
- 11 SWIMMING POOL
- 12 BALCONY
- 13 LAUNDRY



The Grand Mercedes Suite

3 Bedroom





The Grand Mercedes Suite

3 Bedroom Unit

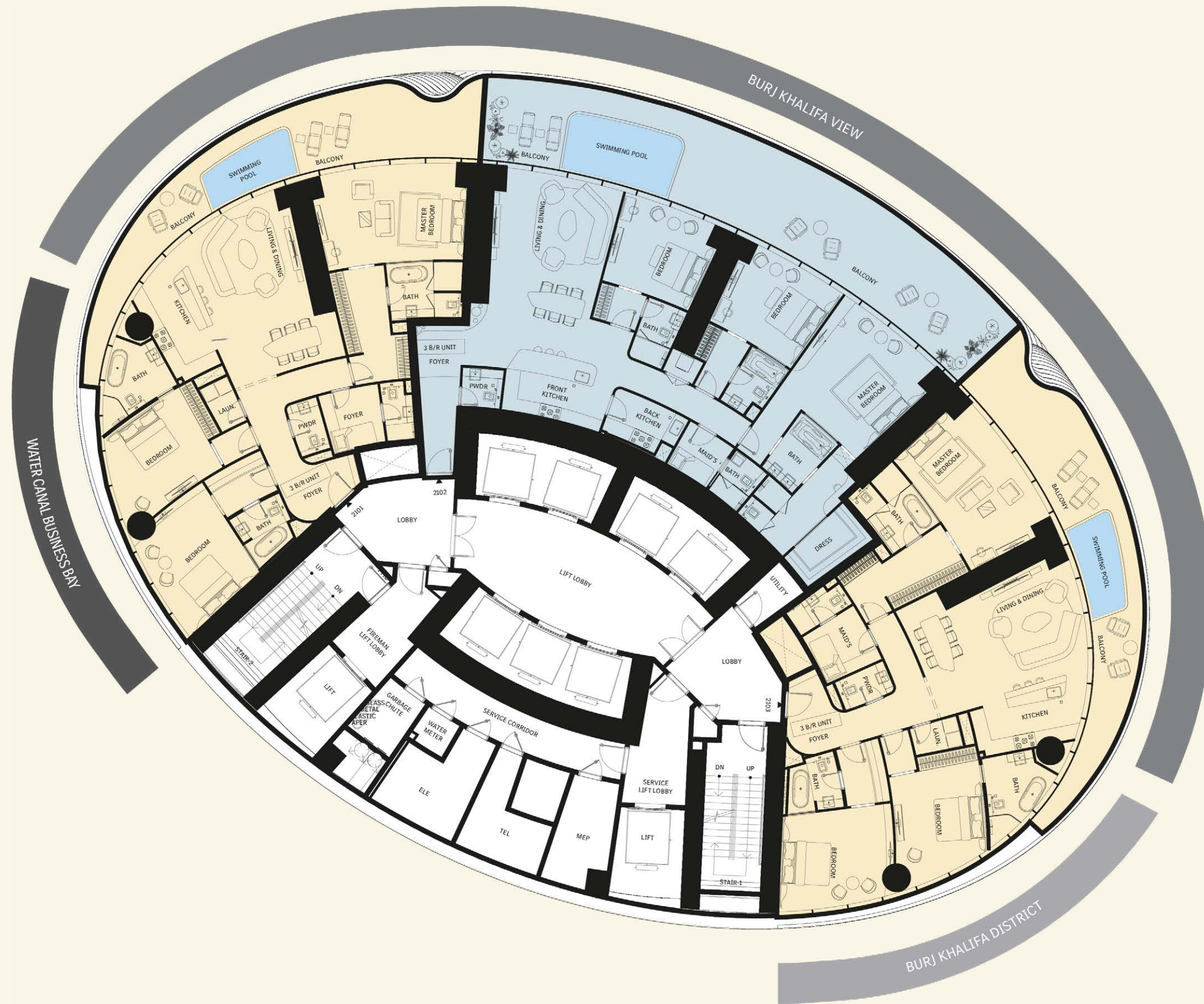

VIEW ANALYSIS

- BURJ KHALIFA - BURJ KHALIFA DISTRICT
- BURJ KHALIFA DISTRICT
- WATER CANAL - BUSINESS BAY

Disclaimer: 1. All stated dimensions and services whether in relation to the building, common areas or individual units are subject to government and local authority approvals. Final dimensions and services will be stated in your sales and purchase agreement 2. All room dimensions are measured to structural elements and exclude wall finishes and construction tolerances. 3. All dimensions have been provided by our consultant architects. 4. All materials, dimensions and drawings are approximate. Information is subject to change without notice. 5. Actual suite area may vary from the stated area. Drawings are not to scale. The Developer reserves the right to make any revisions whatsoever including for aesthetic purposes.

6. Calculation of suite area is measured as the area bounded by the centre line of demising or partition walls separating one unit from another unit, the exterior face of all exterior walls, and the exterior face of the corridor wall enclosing the adjoining unit. 7. Calculation of balcony area is measured as the area bounded by the centre line of demising or partition walls separating one unit from another unit, the outmost face of the enclosing guard and the external face of the adjoining balcony. 8. The units are measured at typical floor in the building. Columns may vary in size depending on the floor level. 9. For each unit type, unit sizes and details might be different and your sales and purchase agreement will contain the actual size of each specific unit.

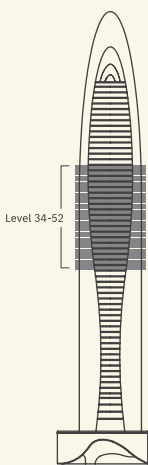

The Grand Mercedes Suite

3 Bedroom Unit | Type 1-A

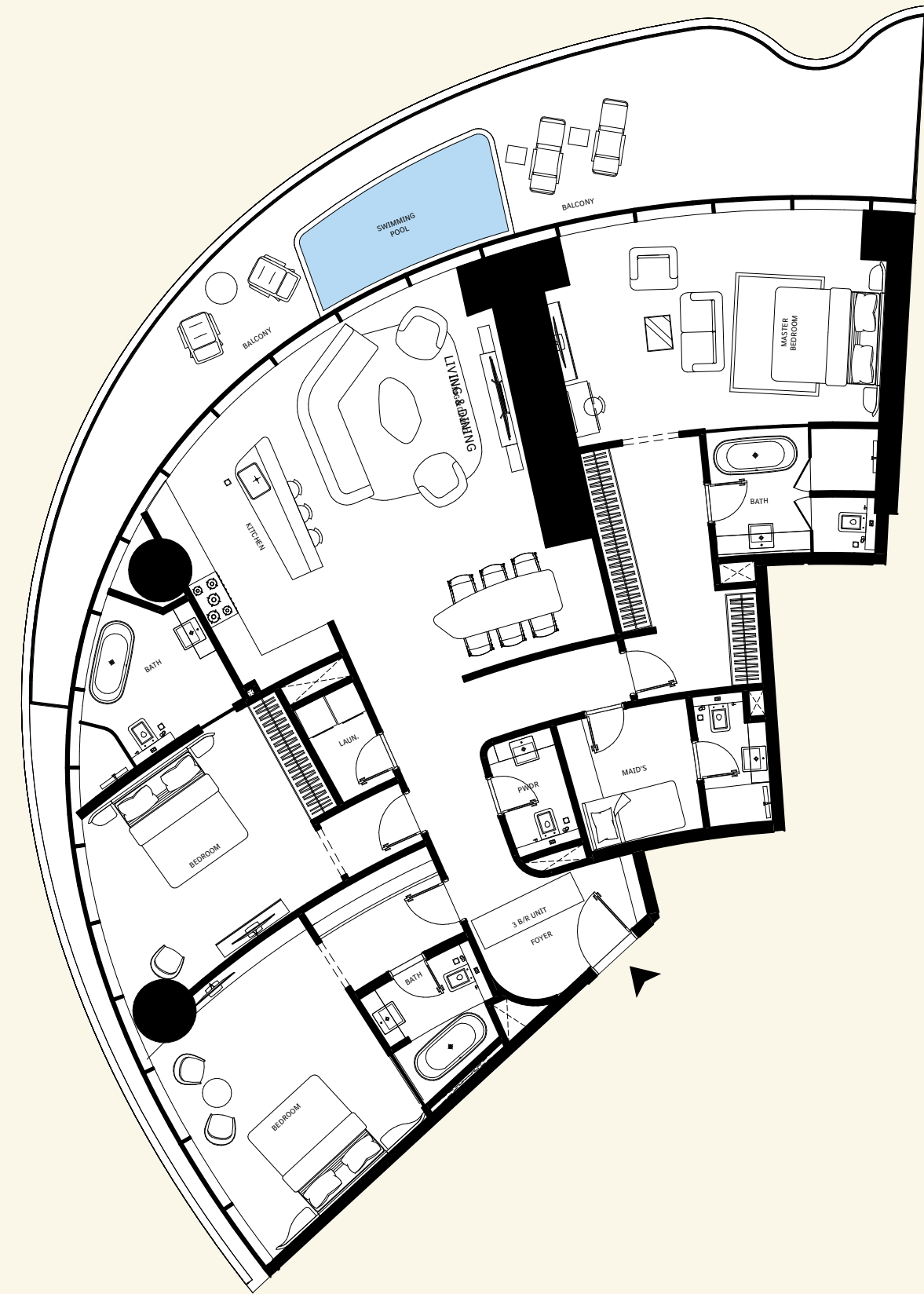

AREA	SQ.M	SQ.FT
Suite Area	201 m ²	2166 ft ²
Balcony Area	51 m ²	544 ft ²
Total Unit Area	252 m ²	2710 ft ²

FLAT DESIGN COMPONENTS	
Living & Dining	35 m ²
Master Bedroom	26 m ²
Bedroom 1	19 m ²
Bedroom 2	19 m ²
Foyer	16 m ²
Dress	11 m ²
Kitchen	11 m ²
Bath 1	8 m ²
Bath 2	7 m ²
Maid	6 m ²
Bath	5 m ²
Dress	5 m ²
Bath	3 m ²
PWDR	3 m ²
Laundry	2 m ²
Lobby	2 m ²

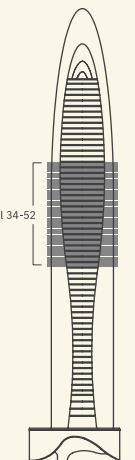

Disclaimer: 1. All stated dimensions and services whether in relation to the building, common areas or individual units are subject to government and local authority approvals. Final dimensions and services will be stated in your sales and purchase agreement 2. All room dimensions are measured to structural elements and exclude wall finishes and construction tolerances. 3. All dimensions have been provided by our consultant architects. 4. All materials, dimensions and drawings are approximate. Information is subject to change without notice. 5. Actual suite area may vary from the stated area. Drawings are not to scale. The Developer reserves the right to make any revisions whatsoever including for aesthetic purposes.

6. Calculation of suite area is measured as the area bounded by the centre line of demising or partition walls separating one unit from another unit, the exterior face of all exterior walls, and the exterior face of the corridor wall enclosing the adjoining unit. 7. Calculation of balcony area is measured as the area bounded by the centre line of demising or partition walls separating one unit from another unit, the outmost face of the enclosing guard and the external face of the adjoining balcony. 8. The units are measured at typical floor in the building. Columns may vary in size depending on the floor level. 9. For each unit type, unit sizes and details might be different and your sales and purchase agreement will contain the actual size of each specific unit.

The Grand Mercedes Suite

3 Bedroom Unit | Type 1
Isometric View



- 1 LIVING LOUNGE
- 2 KITCHEN
- 3 BEDROOM
- 4 BATHROOM SUITE
- 5 LAUNDRY
- 6 BEDROOM
- 7 BATHROOM SUITE
- 8 FOYER
- 9 WC
- 10 HELPER BEDROOM
- 11 MASTER BEDROOM
- 12 MASTER BATHROOM
- 13 SWIMMING POOL
- 14 BALCONY

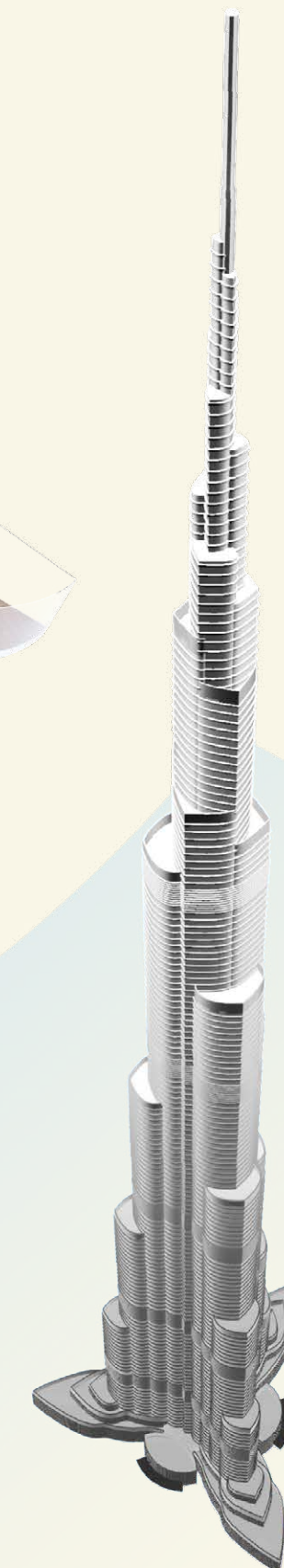

The Grand Mercedes Suite

3 Bedroom Unit | Type 2

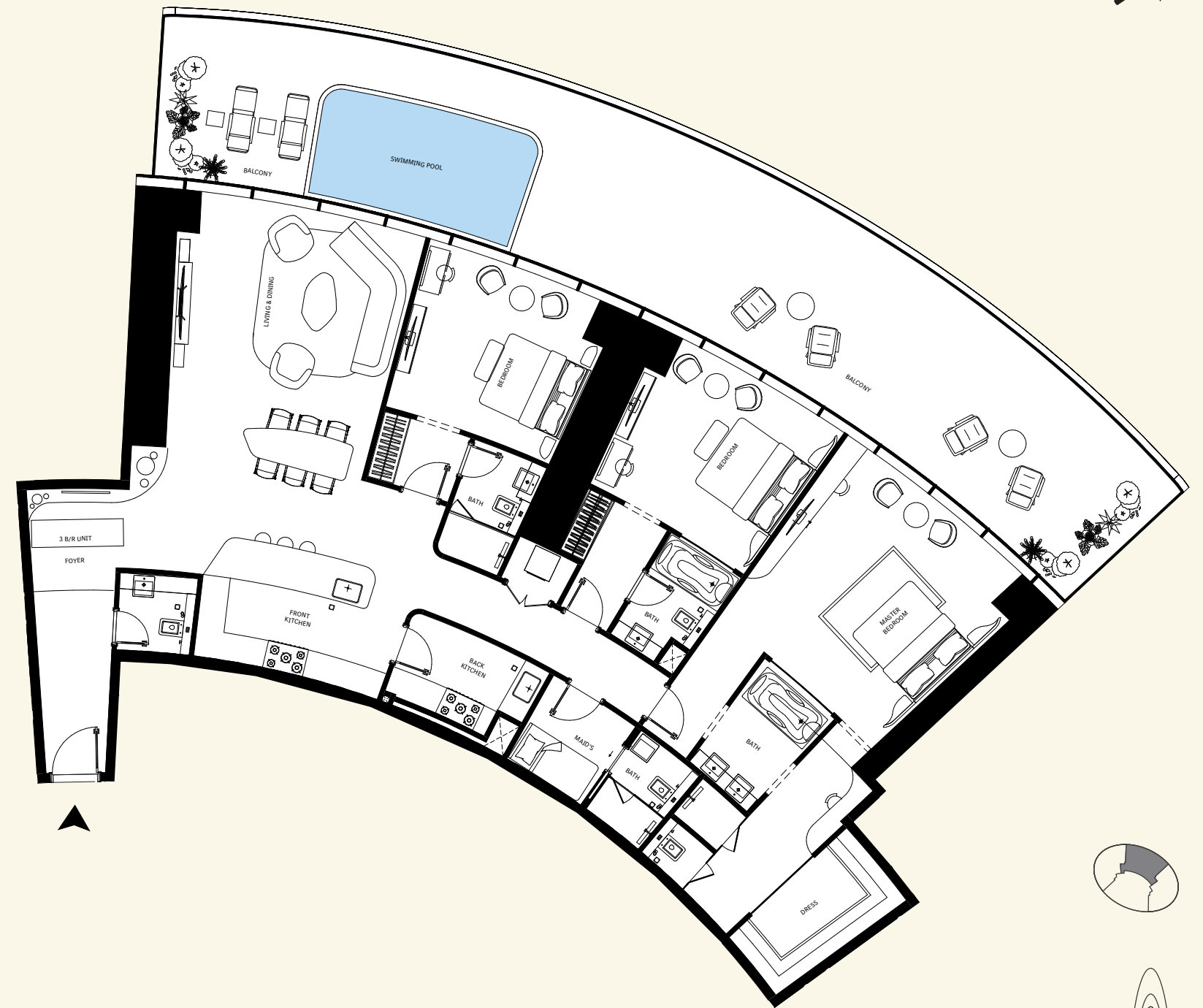

AREA	SQ.M	SQ.FT
Suite Area	215 m ²	2319 ft ²
Balcony Area	90 m ²	966 ft ²
Total Unit Area	305 m ²	3285 ft ²

FLAT DESIGN COMPONENTS	
Living & Dining	40 m ²
Master Bedroom	29 m ²
Bedroom 1	17 m ²
Bedroom 2	16 m ²
Foyer	11 m ²
Lobby	11 m ²
Kitchen	10 m ²
Bath	8 m ²
Dress	7 m ²
Lobby	7 m ²
Back Kitchen	6 m ²
Bath	4 m ²
Bath	4 m ²
Dress	4 m ²
Maid	4 m ²
Bath	3 m ²
Dress	3 m ²
PWDR	3 m ²
Laundry	1 m ²

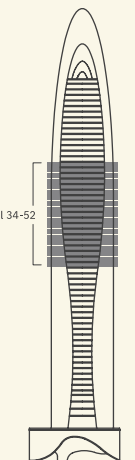

Disclaimer: 1. All stated dimensions and services whether in relation to the building, common areas or individual units are subject to government and local authority approvals. Final dimensions and services will be stated in your sales and purchase agreement 2. All room dimensions are measured to structural elements and exclude wall finishes and construction tolerances. 3. All dimensions have been provided by our consultant architects. 4. All materials, dimensions and drawings are approximate. Information is subject to change without notice. 5. Actual suite area may vary from the stated area. Drawings are not to scale. The Developer reserves the right to make any revisions whatsoever including for aesthetic purposes.

6. Calculation of suite area is measured as the area bounded by the centre line of demising or partition walls separating one unit from another unit, the exterior face of all exterior walls, and the exterior face of the corridor wall enclosing the adjoining unit. 7. Calculation of balcony area is measured as the area bounded by the centre line of demising or partition walls separating one unit from another unit, the outmost face of the enclosing guard and the external face of the adjoining balcony. 8. The units are measured at typical floor in the building. Columns may vary in size depending on the floor level. 9. For each unit type, unit sizes and details might be different and your sales and purchase agreement will contain the actual size of each specific unit.

The Grand Mercedes Suite

3 Bedroom Unit | Type 2
Isometric View



- 1 LIVING LOUNGE
- 2 BEDROOM
- 3 BATHROOM SUITE
- 4 BEDROOM
- 5 BATHROOM SUITE
- 6 MASTER BEDROOM
- 7 MASTER BATHROOM
- 8 WALK-IN CLOSET
- 9 HELPER BEDROOM
- 10 FRONT KITCHEN
- 11 BACK KITCHEN
- 12 FOYER
- 13 SWIMMING POOL
- 14 BALCONY

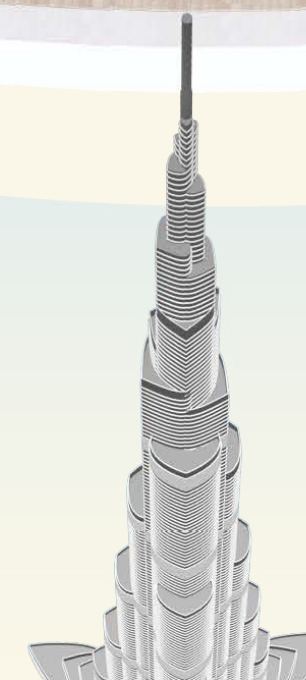

Mercedes-Benz Places | Binghatti Penthouses



The Mercedes-Benz Vision One-Eleven Penthouse

4 Bedroom

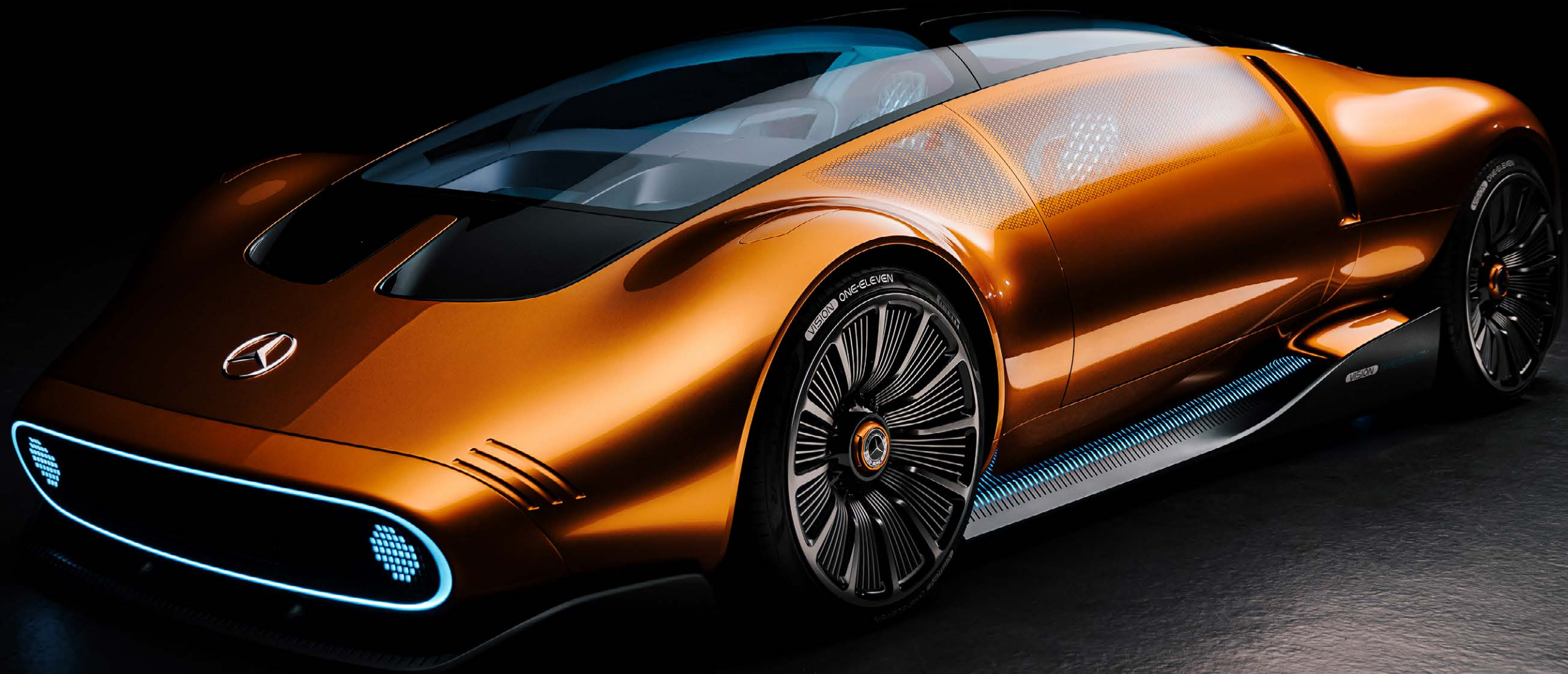

The Mercedes-Benz Vision One-Eleven Penthouse

4 Bedroom Unit

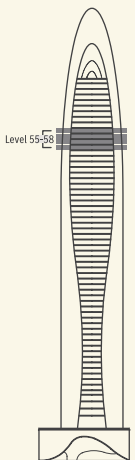
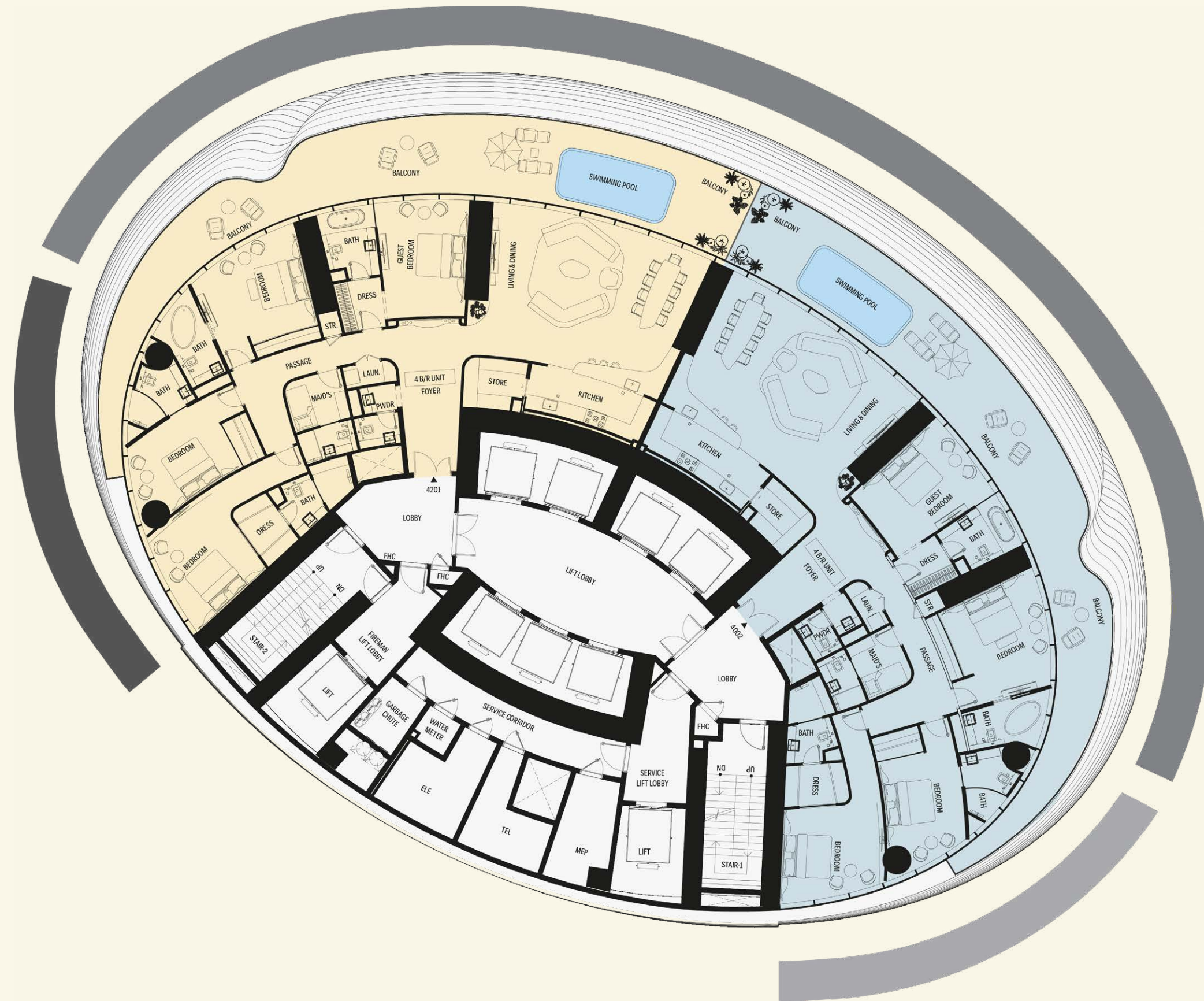

VIEW ANALYSIS

- BURJ KHALIFA - BURJ KHALIFA DISTRICT
- BURJ KHALIFA DISTRICT
- WATER CANAL - BUISINESS BAY

Disclaimer: 1. All stated dimensions and services whether in relation to the building, common areas or individual units are subject to government and local authority approvals. Final dimensions and services will be stated in your sales and purchase agreement 2. All room dimensions are measured to structural elements and exclude wall finishes and construction tolerances. 3. All dimensions have been provided by our consultant architects. 4. All materials, dimensions and drawings are approximate. Information is subject to change without notice. 5. Actual suite area may vary from the stated area. Drawings are not to scale. The Developer reserves the right to make any revisions whatsoever including for aesthetic purposes.

6. Calculation of suite area is measured as the area bounded by the centre line of demising or partition walls separating one unit from another unit, the exterior face of all exterior walls, and the exterior face of the corridor wall enclosing the adjoining unit. 7. Calculation of balcony area is measured as the area bounded by the centre line of demising or partition walls separating one unit from another unit, the outmost face of the enclosing guard and the external face of the adjoining balcony. 8. The units are measured at typical floor in the building. Columns may vary in size depending on the floor level. 9. For each unit type, unit sizes and details might be different and your sales and purchase agreement will contain the actual size of each specific unit.

The Mercedes-Benz Vision One-Eleven Penthouse

4 Bedroom Unit | Type 1-A

AREA	SQ.M	SQ.FT
Suite Area	278 m ²	2995 ft ²
Balcony Area	94 m ²	1013 ft ²
Total Unit Area	372 m ²	3007 ft ²

FLAT DESIGN COMPONENTS	
LIVING & DINING	63 m ²
BEDROOM	22 m ²
GUEST BEDROOM	21 m ²
BEDROOM	18 m ²
BEDROOM	16 m ²
FOYER	16 m ²
PASSAGE	14 m ²
KITCHEN	10 m ²
BATH	9 m ²
BATH	8 m ²
BATH	7 m ²
BATH	6 m ²
MAID	5 m ²
STORE	5 m ²
DRESS	4 m ²
DRESS	3 m ²
BATH	3 m ²
DRESS	3 m ²
LOBBY	3 m ²
DRESS	2 m ²
LAUN.	2 m ²
PWDR	2 m ²
WASH	2 m ²
LOBBY	1 m ²
STORE	1 m ²

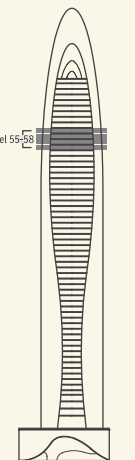

Disclaimer: 1. All stated dimensions and services whether in relation to the building, common areas or individual units are subject to government and local authority approvals. Final dimensions and services will be stated in your sales and purchase agreement 2. All room dimensions are measured to structural elements and exclude wall finishes and construction tolerances. 3. All dimensions have been provided by our consultant architects. 4. All materials, dimensions and drawings are approximate. Information is subject to change without notice. 5. Actual suite area may vary from the stated area. Drawings are not to scale. The Developer reserves the right to make any revisions whatsoever including for aesthetic purposes.

6. Calculation of suite area is measured as the area bounded by the centre line of demising or partition walls separating one unit from another unit, the exterior face of all exterior walls, and the exterior face of the corridor wall enclosing the adjoining unit. 7. Calculation of balcony area is measured as the area bounded by the centre line of demising or partition walls separating one unit from another unit, the outmost face of the enclosing guard and the external face of the adjoining balcony. 8. The units are measured at typical floor in the building. Columns may vary in size depending on the floor level. 9. For each unit type, unit sizes and details might be different and your sales and purchase agreement will contain the actual size of each specific unit.

The Mercedes-Benz Vision One-Eleven Penthouse

4 Bedroom Unit | Type 1
Isometric View

- 1 LIVING LOUNGE
- 2 BEDROOM
- 3 BEDROOM
- 4 BEDROOM
- 5 MASTER BEDROOM
- 6 BATHROOM SUITE
- 7 BATHROOM SUITE
- 8 BATHROOM SUITE
- 9 BATHROOM SUITE
- 10 FOYER
- 11 WC
- 12 KITCHEN
- 13 STORE
- 14 HELPER BEDROOM
- 15 SWIMMING POOL
- 16 BALCONY



The Mercedes-Benz Gullwing Penthouse

5 Bedroom



The Mercedes-Benz Gullwing Penthouse

5 Bedroom | Penthouse

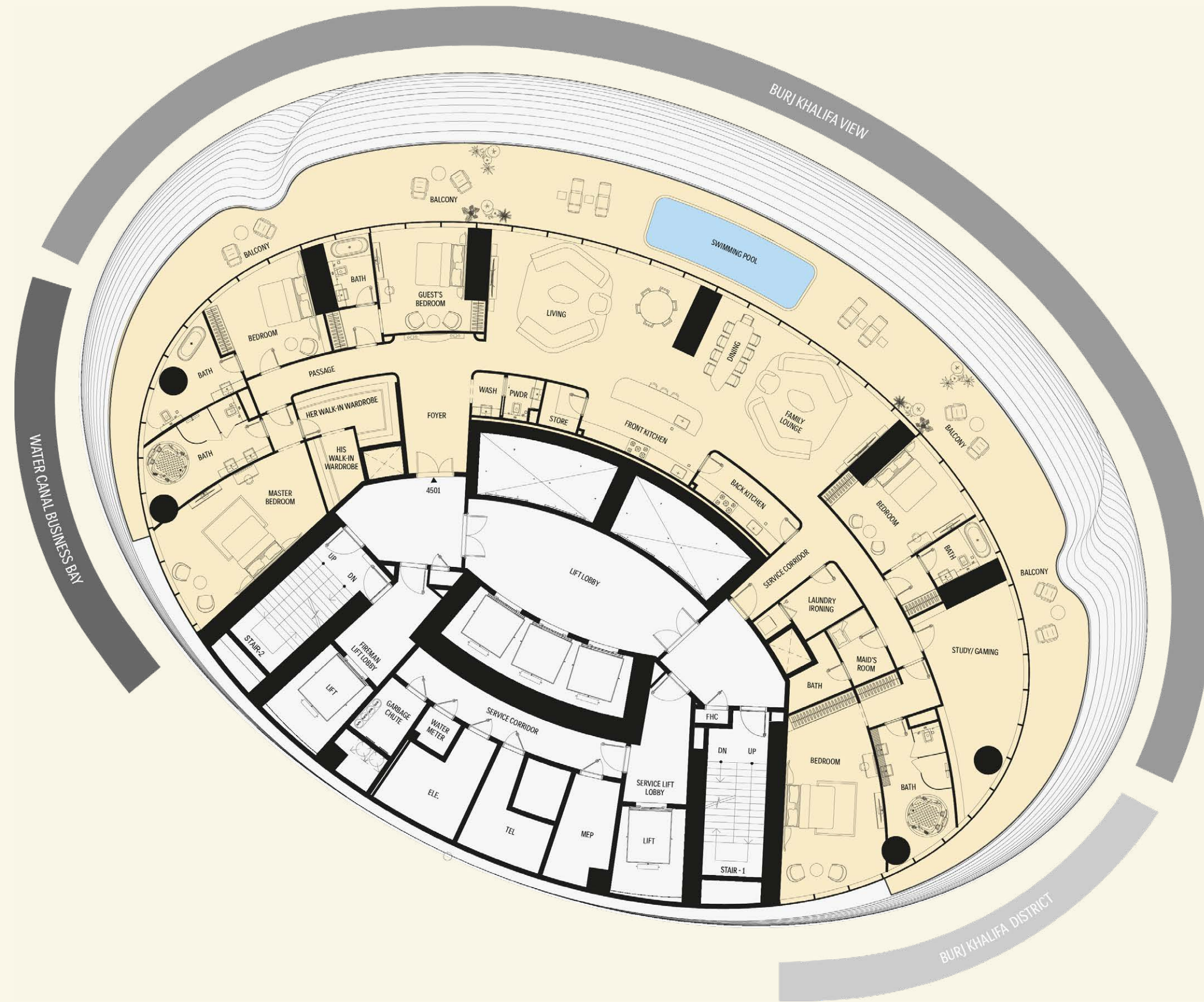

VIEW ANALYSIS

- BURJ KHALIFA - BURJ KHALIFA DISTRICT
- BURJ KHALIFA DISTRICT
- WATER CANAL - BUSINESS BAY

Disclaimer: 1. All stated dimensions and services whether in relation to the building, common areas or individual units are subject to government and local authority approvals. Final dimensions and services will be stated in your sales and purchase agreement 2. All room dimensions are measured to structural elements and exclude wall finishes and construction tolerances. 3. All dimensions have been provided by our consultant architects. 4. All materials, dimensions and drawings are approximate. Information is subject to change without notice. 5. Actual suite area may vary from the stated area. Drawings are not to scale. The Developer reserves the right to make any revisions whatsoever including for aesthetic purposes.

6. Calculation of suite area is measured as the area bounded by the centre line of demising or partition walls separating one unit from another unit, the exterior face of all exterior walls, and the exterior face of the corridor wall enclosing the adjoining unit. 7. Calculation of balcony area is measured as the area bounded by the centre line of demising or partition walls separating one unit from another unit, the outmost face of the enclosing guard and the external face of the adjoining balcony. 8. The units are measured at typical floor in the building. Columns may vary in size depending on the floor level. 9. For each unit type, unit sizes and details might be different and your sales and purchase agreement will contain the actual size of each specific unit.

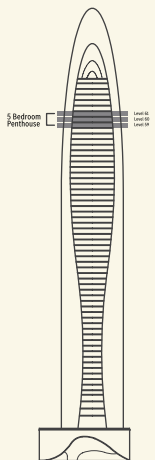

The Mercedes-Benz Gullwing Penthouse

5 Bedroom | Penthouse

AREA	SQ.M	SQ.FT
Suite Area	456 m ²	4911 ft ²
Balcony Area	184 m ²	1980 ft ²
Total Unit Area	640 m ²	6891 ft ²

FLAT DESIGN COMPONENTS	
LIVING	36 m ²
FAMILY LOUNGE	34 m ²
BEDROOM	31 m ²
DINING	30 m ²
MASTER BEDROOM	30 m ²
STUDY / GAMING	29 m ²
BEDROOM	19 m ²
BEDROOM	18 m ²
GUESTS BEDROOM	18 m ²
FOYER	17 m ²
SERVICE CORRIDOR	16 m ²
BATH	15 m ²
BATH	15 m ²
BATH	11 m ²
FRONT KITCHEN	10 m ²
HER WALK-IN WARDROBE	9 m ²
BACK KITCHEN	8 m ²
PASSAGE	8 m ²
BATH	6 m ²
BATH	6 m ²
DRESS	6 m ²
LAUNDRY IRONING	6 m ²
BATH	5 m ²
HIS WALK-IN WARDROBE	5 m ²
MAID	5 m ²
DRESS	3 m ²
DRESS	3 m ²
STORE	3 m ²
LOBBY	2 m ²
PWDR	2 m ²
WASH	2 m ²
WM.	1 m ²

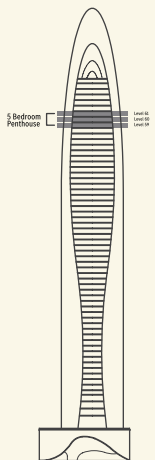
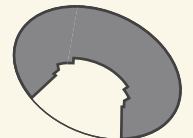
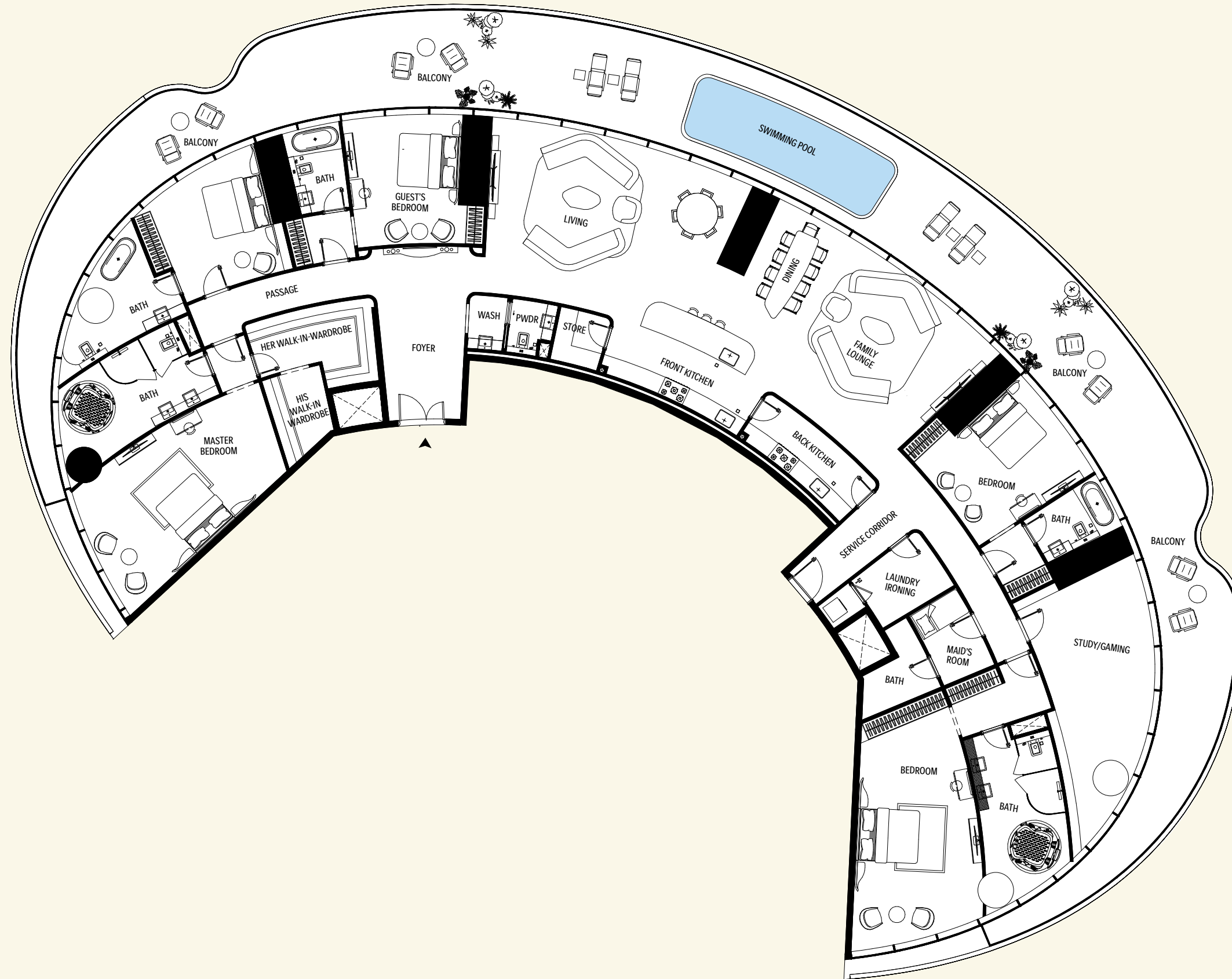

Disclaimer: 1. All stated dimensions and services whether in relation to the building, common areas or individual units are subject to government and local authority approvals. Final dimensions and services will be stated in your sales and purchase agreement 2. All room dimensions are measured to structural elements and exclude wall finishes and construction tolerances. 3. All dimensions have been provided by our consultant architects. 4. All materials, dimensions and drawings are approximate. Information is subject to change without notice. 5. Actual suite area may vary from the stated area. Drawings are not to scale. The Developer reserves the right to make any revisions whatsoever including for aesthetic purposes.

6. Calculation of suite area is measured as the area bounded by the centre line of demising or partition walls separating one unit from another unit, the exterior face of all exterior walls, and the exterior face of the corridor wall enclosing the adjoining unit. 7. Calculation of balcony area is measured as the area bounded by the centre line of demising or partition walls separating one unit from another unit, the outmost face of the enclosing guard and the external face of the adjoining balcony. 8. The units are measured at typical floor in the building. Columns may vary in size depending on the floor level. 9. For each unit type, unit sizes and details might be different and your sales and purchase agreement will contain the actual size of each specific unit.

The Mercedes-Benz Gullwing Penthouse

5 Bedroom | Penthouse
Isometric View



- 1 BEDROOM
- 2 BATHROOM SUITE
- 3 STUDY/GAMING
- 4 BATHROOM SUITE
- 5 BEDROOM
- 6 FAMILY LOUNGE
- 7 BALCONY
- 8 BACK KITCHEN
- 9 FRONT KITCHEN
- 10 DINING
- 11 LIVING
- 12 FOYER
- 13 HER WALK-IN WARDROBE
- 14 HIS WALK-IN WARDROBE
- 15 MASTER BEDROOM
- 16 MASTER BATHROOM
- 17 BEDROOM
- 18 BATHROOM SUITE
- 19 GUEST'S ROOM
- 20 BATHROOM SUITE
- 21 SWIMMING POOL



The Mercedes-Benz Vision EQ Silver Arrow Penthouse

6 Bedroom Duplex

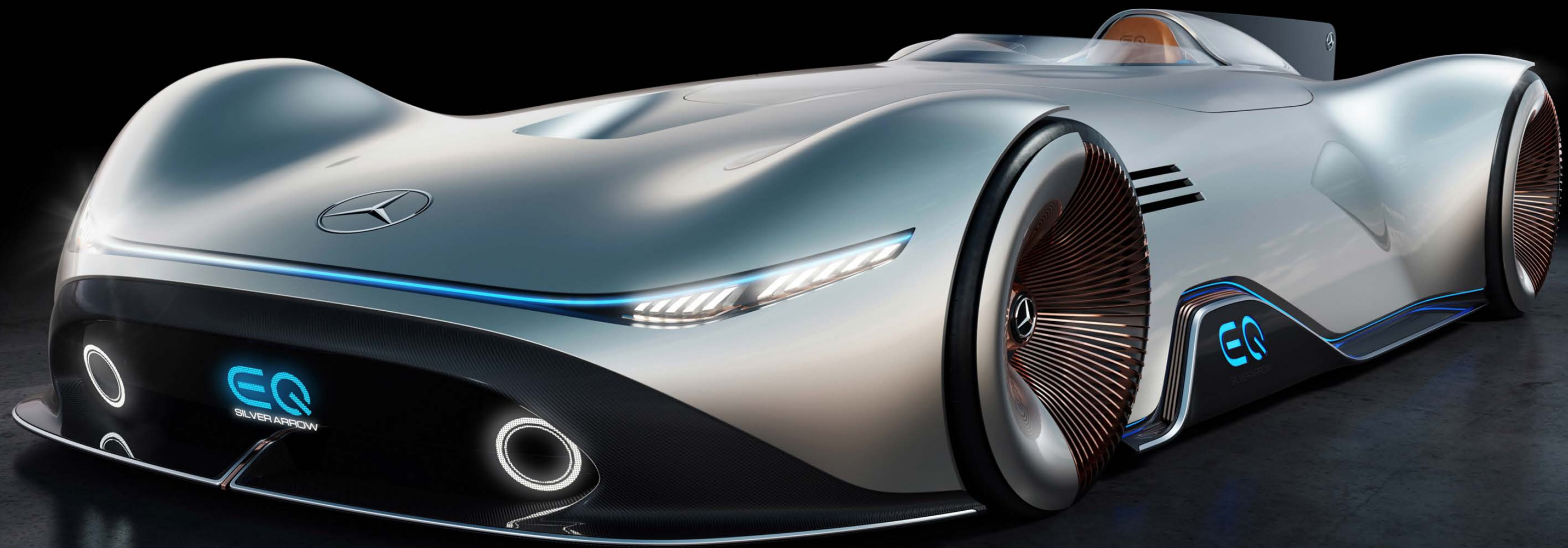

The Mercedes-Benz Vision EQ Silver Arrow Penthouse

The Duplex Penthouse

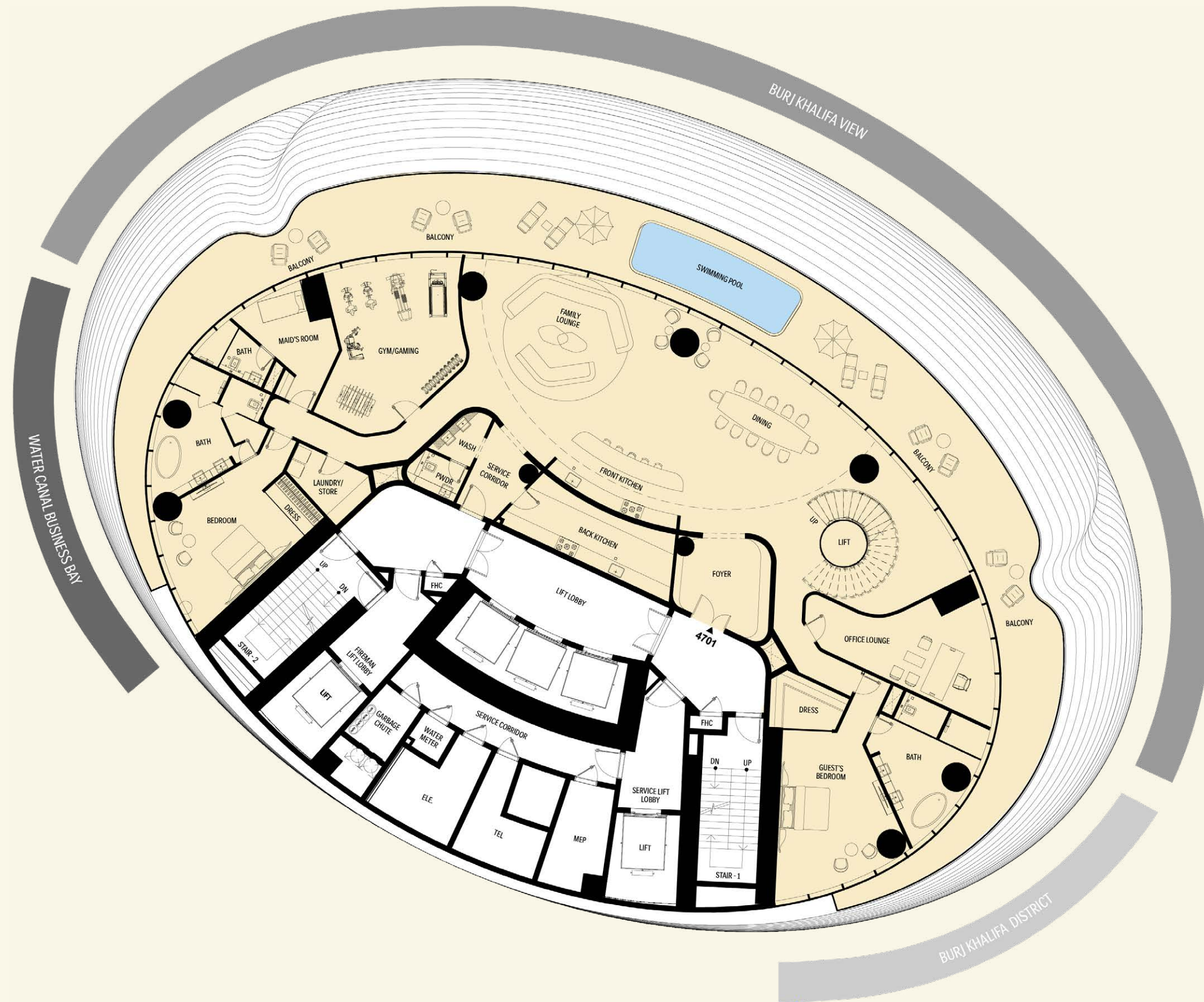

VIEW ANALYSIS

- BURJ KHALIFA - BURJ KHALIFA DISTRICT
- BURJ KHALIFA DISTRICT
- WATER CANAL - BUSINESS BAY

Disclaimer: 1. All stated dimensions and services whether in relation to the building, common areas or individual units are subject to government and local authority approvals. Final dimensions and services will be stated in your sales and purchase agreement 2. All room dimensions are measured to structural elements and exclude wall finishes and construction tolerances. 3. All dimensions have been provided by our consultant architects. 4. All materials, dimensions and drawings are approximate. Information is subject to change without notice. 5. Actual suite area may vary from the stated area. Drawings are not to scale. The Developer reserves the right to make any revisions whatsoever including for aesthetic purposes.

6. Calculation of suite area is measured as the area bounded by the centre line of demising or partition walls separating one unit from another unit, the exterior face of all exterior walls, and the exterior face of the corridor wall enclosing the adjoining unit. 7. Calculation of balcony area is measured as the area bounded by the centre line of demising or partition walls separating one unit from another unit, the outmost face of the enclosing guard and the external face of the adjoining balcony. 8. The units are measured at typical floor in the building. Columns may vary in size depending on the floor level. 9. For each unit type, unit sizes and details might be different and your sales and purchase agreement will contain the actual size of each specific unit.

The Mercedes-Benz Vision EQ Silver Arrow Penthouse

The Duplex Penthouse | Level 1

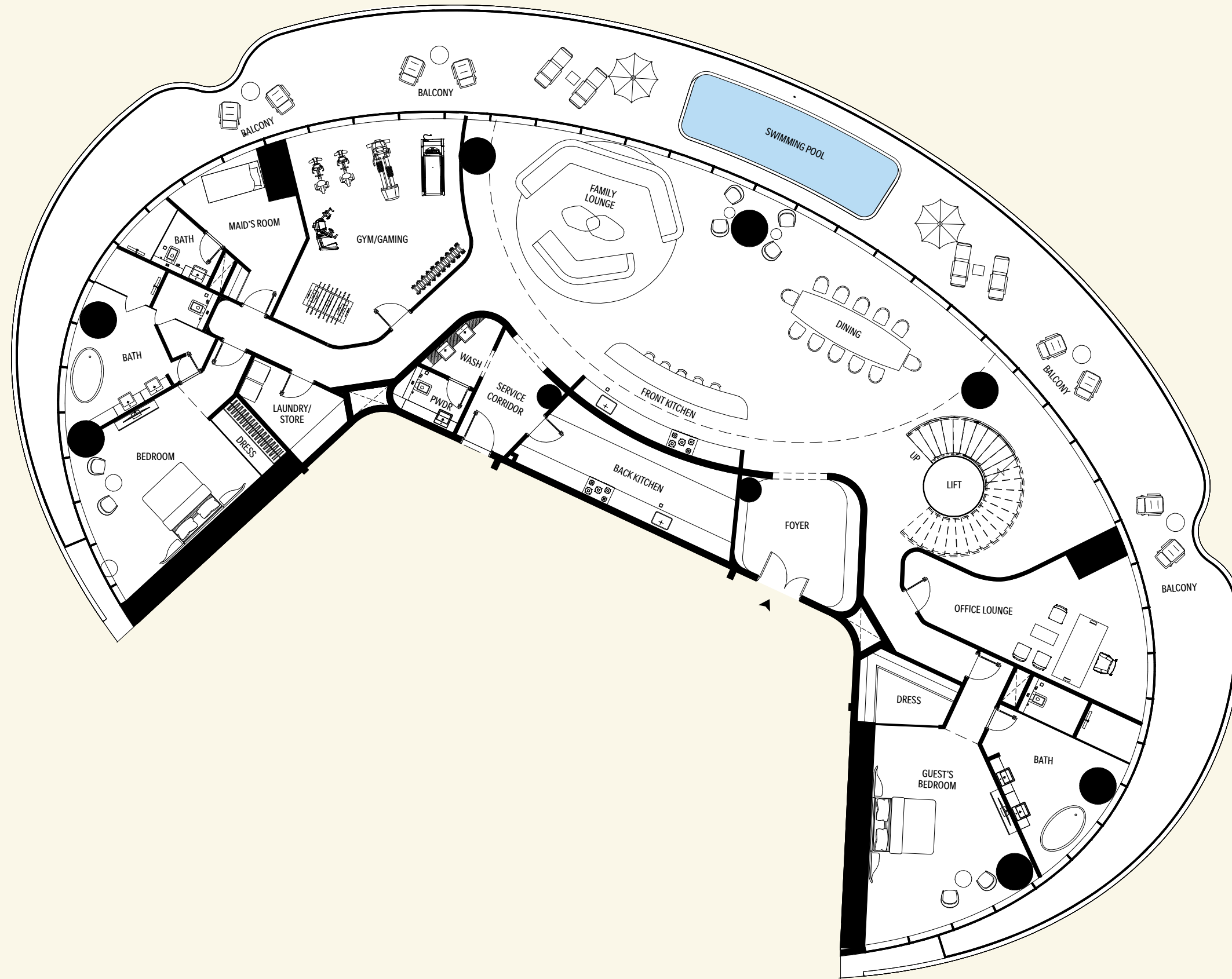

AREA	SQ.M	SQ.FT
Suite Area	457 m ²	4923 ft ²
Balcony Area	185 m ²	1987 ft ²
Total Unit Area	642 m ²	6909 ft ²

FLAT DESIGN COMPONENTS	
FAMILY LOUNGE	44 m ²
LIVING	41 m ²
GYM / GAMING	37 m ²
STAIR LOBBY	33 m ²
GUESTS BEDROOM	29 m ²
DINING	28 m ²
OFFICE LOUNGE	27 m ²
BEDROOM	24 m ²
BATH	20 m ²
BATH	19 m ²
BACK KITCHEN	18 m ²
FOYER	14 m ²
MAID'S ROOM	13 m ²
PASSAGE	13 m ²
FRONT KITCHEN	12 m ²
PASSAGE	8 m ²
LAUN. / STORE	7 m ²
SERVICE LOBBY	7 m ²
DRESS	6 m ²
BATH	5 m ²
DRESS	3 m ²
LIFT	3 m ²
LOBBY	3 m ²
LOBBY	3 m ²
PWDR	3 m ²
WASH	3 m ²

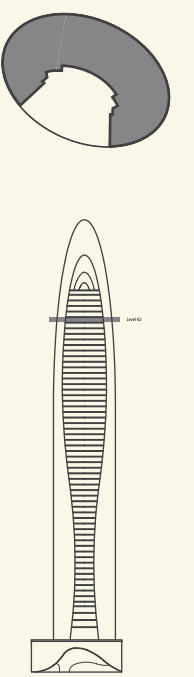

Disclaimer: 1. All stated dimensions and services whether in relation to the building, common areas or individual units are subject to government and local authority approvals. Final dimensions and services will be stated in your sales and purchase agreement 2. All room dimensions are measured to structural elements and exclude wall finishes and construction tolerances. 3. All dimensions have been provided by our consultant architects. 4. All materials, dimensions and drawings are approximate. Information is subject to change without notice. 5. Actual suite area may vary from the stated area. Drawings are not to scale. The Developer reserves the right to make any revisions whatsoever including for aesthetic purposes.

6. Calculation of suite area is measured as the area bounded by the centre line of demising or partition walls separating one unit from another unit, the exterior face of all exterior walls, and the exterior face of the corridor wall enclosing the adjoining unit. 7. Calculation of balcony area is measured as the area bounded by the centre line of demising or partition walls separating one unit from another unit, the outmost face of the enclosing guard and the external face of the adjoining balcony. 8. The units are measured at typical floor in the building. Columns may vary in size depending on the floor level. 9. For each unit type, unit sizes and details might be different and your sales and purchase agreement will contain the actual size of each specific unit.

The Mercedes-Benz Vision EQ Silver Arrow Penthouse

The Duplex Penthouse | Level 1
Isometric View



- 1 GUEST'S BEDROOM
- 2 WASHROOM
- 3 BATHROOM SUITE
- 4 DINING
- 5 WALK-IN WARDROBE
- 6 FAMILY LOUNGE
- 7 OFFICE LOUNGE
- 8 GYM/GAMING
- 9 BALCONY
- 10 HELPER BEDROOM
- 11 LIFT
- 12 BATHROOM SUITE
- 13 FOYER
- 14 WALK-IN WARDROBE
- 15 BACK KITCHEN
- 16 BEDROOM
- 17 FRONT KITCHEN
- 18 BATHROOM SUITE
- 19 SERVICE CORRIDOR
- 20 LAUNDRY/STORE
- 21 WC
- 22 SWIMMING POOL



The Mercedes-Benz Vision EQ Silver Arrow Penthouse

The Duplex Penthouse | Level 2

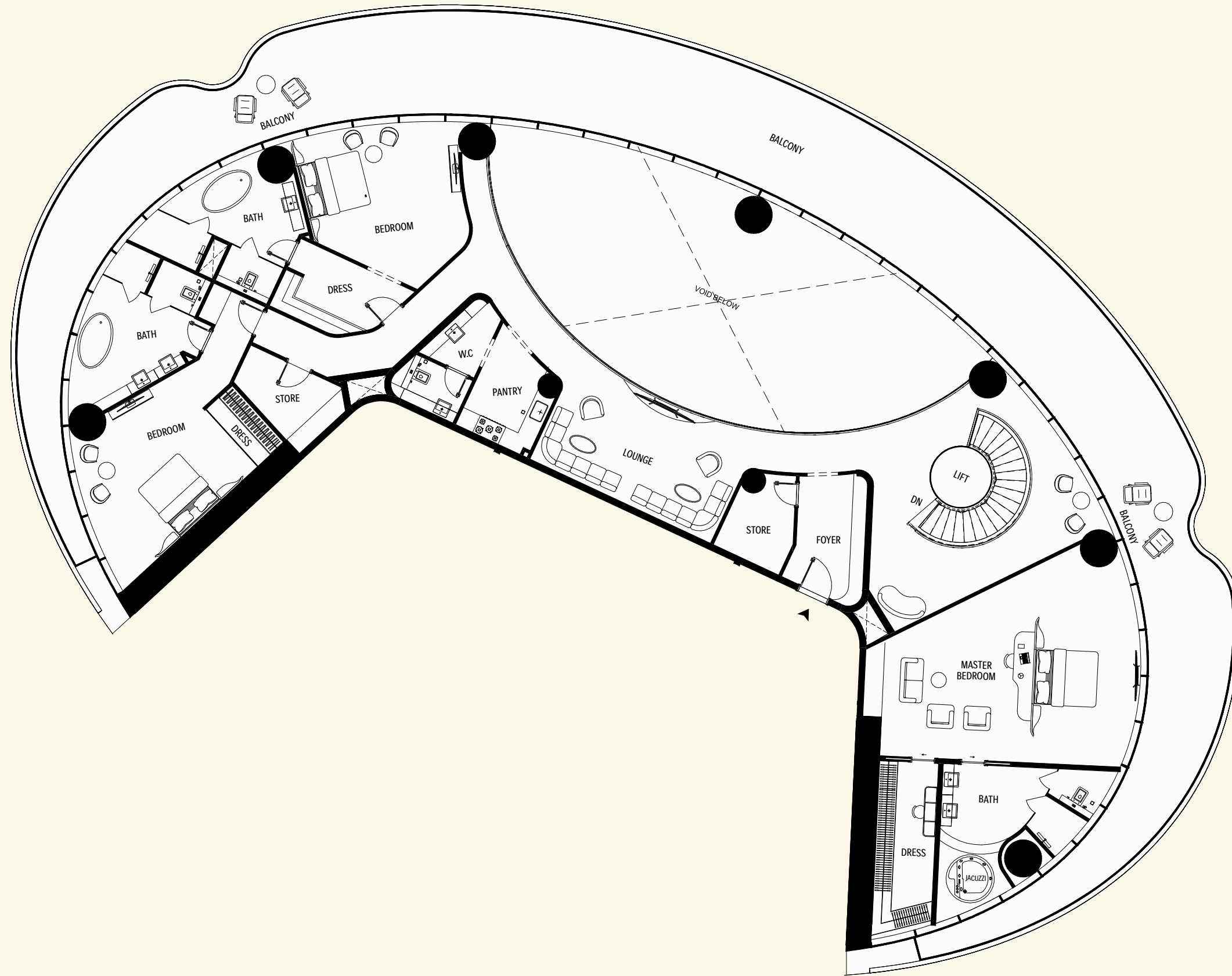

AREA	SQ.M	SQ.FT
Suite Area	331 m ²	3566 ft ²
Balcony Area	186 m ²	2000 ft ²
Total Unit Area	517 m ²	5566 ft ²

FLAT DESIGN COMPONENTS	
MASTER BEDROOM	49 m ²
STAIR LOBBY	38 m ²
BEDROOM	25 m ²
LOUNGE	24 m ²
BEDROOM	23 m ²
PASSAGE	19 m ²
BATH	18 m ²
BATH	17 m ²
BATH	16 m ²
DRESS	11 m ²
FOYER	9 m ²
DRESS	8 m ²
PANTRY	7 m ²
STORE	7 m ²
STORE	6 m ²
LOBBY	5 m ²
PASSAGE	5 m ²
DRESS	3 m ²
LIFT	3 m ²
WASH	3 m ²
WC	3 m ²

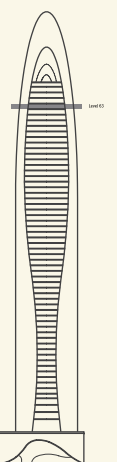
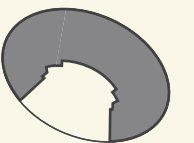

Disclaimer: 1. All stated dimensions and services whether in relation to the building, common areas or individual units are subject to government and local authority approvals. Final dimensions and services will be stated in your sales and purchase agreement 2. All room dimensions are measured to structural elements and exclude wall finishes and construction tolerances. 3. All dimensions have been provided by our consultant architects. 4. All materials, dimensions and drawings are approximate. Information is subject to change without notice. 5. Actual suite area may vary from the stated area. Drawings are not to scale. The Developer reserves the right to make any revisions whatsoever including for aesthetic purposes.

6. Calculation of suite area is measured as the area bounded by the centre line of demising or partition walls separating one unit from another unit, the exterior face of all exterior walls, and the exterior face of the corridor wall enclosing the adjoining unit. 7. Calculation of balcony area is measured as the area bounded by the centre line of demising or partition walls separating one unit from another unit, the outmost face of the enclosing guard and the external face of the adjoining balcony. 8. The units are measured at typical floor in the building. Columns may vary in size depending on the floor level. 9. For each unit type, unit sizes and details might be different and your sales and purchase agreement will contain the actual size of each specific unit.

The Mercedes-Benz Vision EQ Silver Arrow Penthouse

The Duplex Penthouse | Level 2
Isometric View



- 1 WALK-IN WARDROBE
- 2 BATHROOM SUITE
- 3 MASTER BEDROOM
- 4 FOYER
- 5 BALCONY
- 6 LIFT
- 7 STORE
- 8 LOUNGE
- 9 PANTRY
- 10 WC
- 11 BEDROOM
- 12 WALK-IN WARDROBE
- 13 BATHROOM SUITE
- 14 STORE
- 15 BEDROOM
- 16 BATHROOM SUITE



The Mercedes-Benz Uhlenhaut Coupé Penthouse

7 Bedroom Triplex



The Mercedes-Benz Uhlenhaut Coupé Penthouse

The Triplex Penthouse

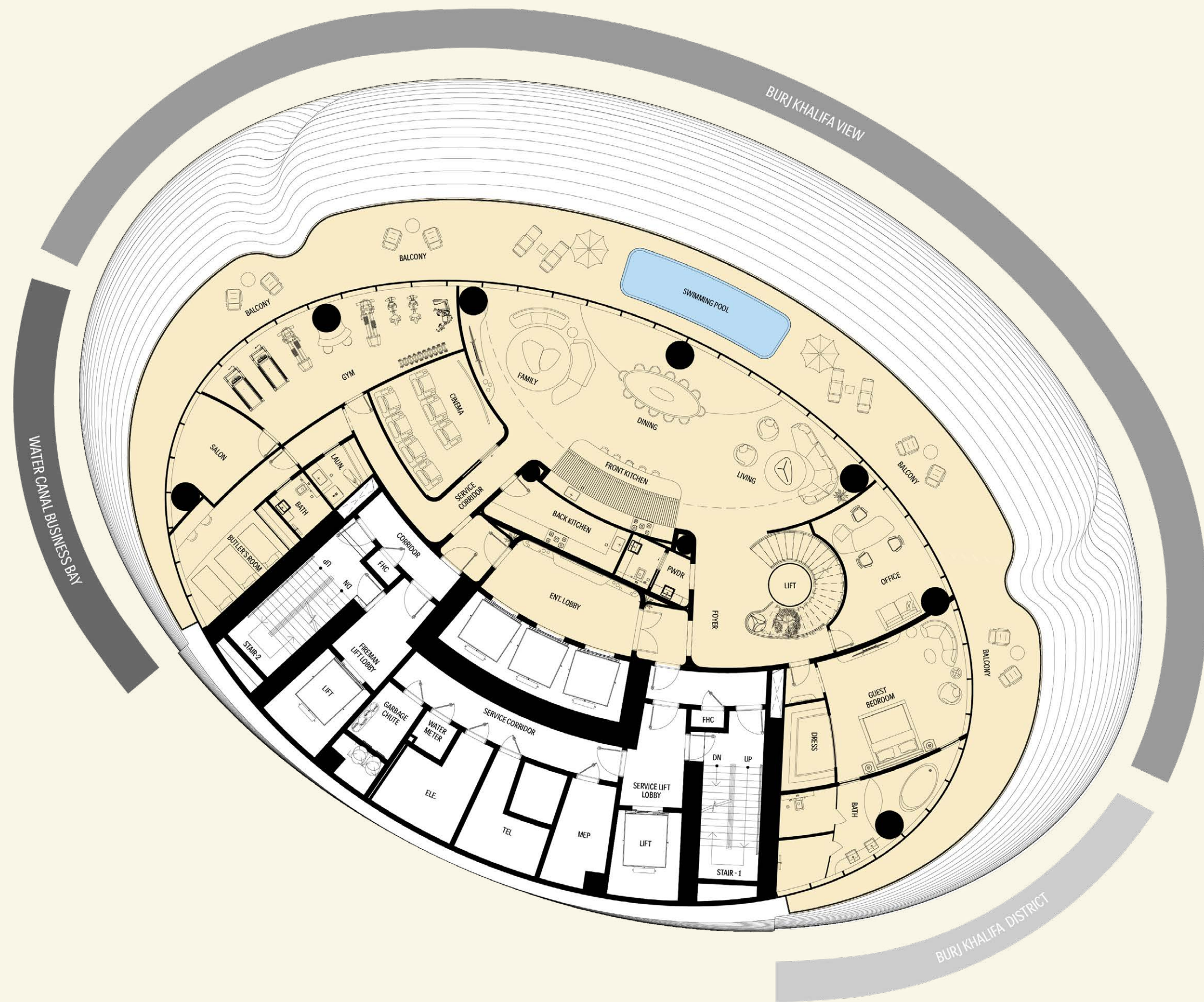

VIEW ANALYSIS

- BURJ KHALIFA - BURJ KHALIFA DISTRICT
- BURJ KHALIFA DISTRICT
- WATER CANAL - BUSINESS BAY

Disclaimer: 1. All stated dimensions and services whether in relation to the building, common areas or individual units are subject to government and local authority approvals. Final dimensions and services will be stated in your sales and purchase agreement 2. All room dimensions are measured to structural elements and exclude wall finishes and construction tolerances. 3. All dimensions have been provided by our consultant architects. 4. All materials, dimensions and drawings are approximate. Information is subject to change without notice. 5. Actual suite area may vary from the stated area. Drawings are not to scale. The Developer reserves the right to make any revisions whatsoever including for aesthetic purposes.

6. Calculation of suite area is measured as the area bounded by the centre line of demising or partition walls separating one unit from another unit, the exterior face of all exterior walls, and the exterior face of the corridor wall enclosing the adjoining unit. 7. Calculation of balcony area is measured as the area bounded by the centre line of demising or partition walls separating one unit from another unit, the outmost face of the enclosing guard and the external face of the adjoining balcony. 8. The units are measured at typical floor in the building. Columns may vary in size depending on the floor level. 9. For each unit type, unit sizes and details might be different and your sales and purchase agreement will contain the actual size of each specific unit.

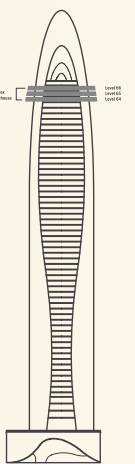

The Mercedes-Benz Uhlenhaut Coupé Penthouse

The Triplex Penthouse | Level 1

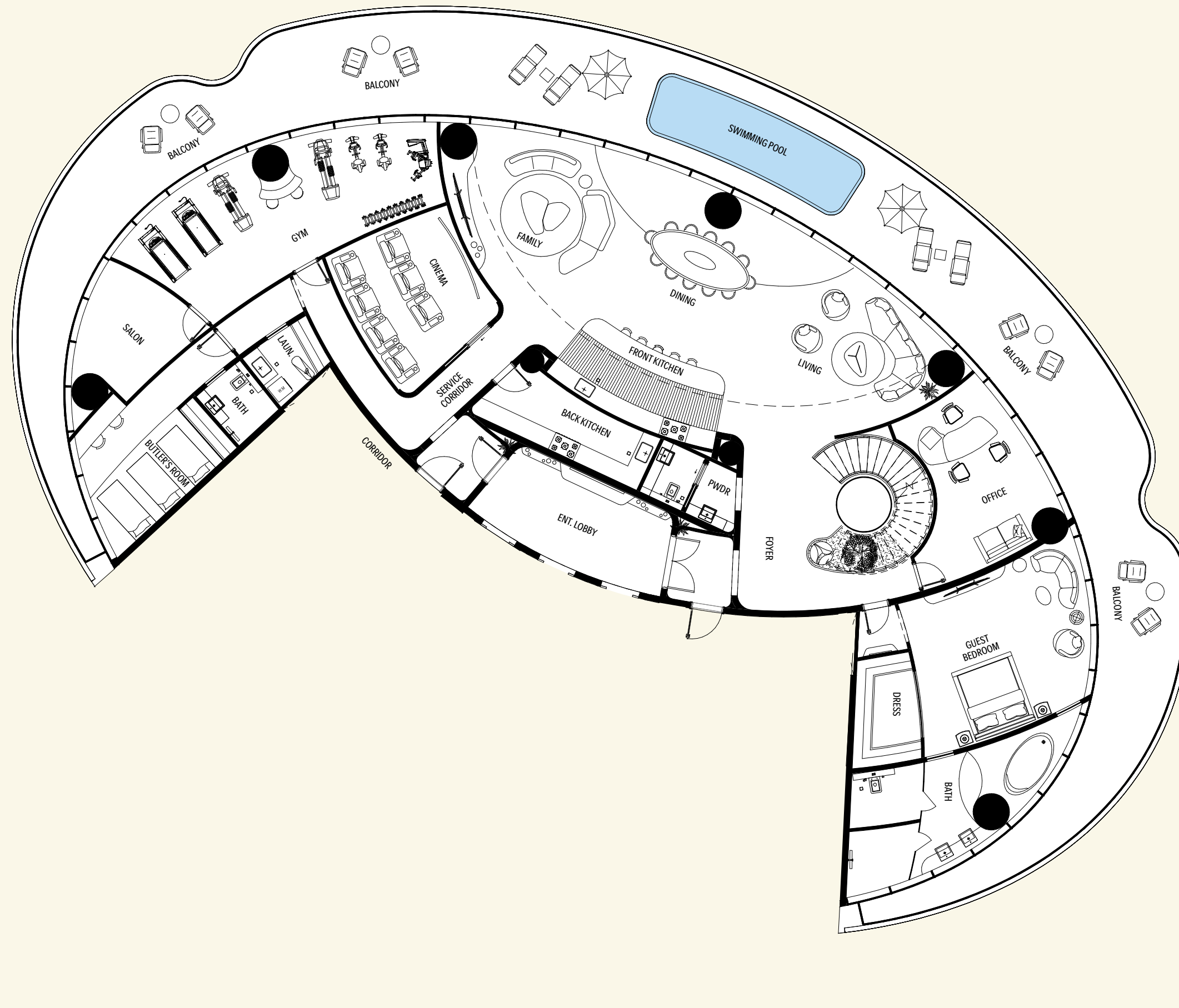

AREA	SQ.M	SQ.FT
Suite Area	410 m ²	4416 ft ²
Balcony Area	188 m ²	2022 ft ²
Total Unit Area	598 m ²	6437 ft ²

FLAT DESIGN COMPONENTS	
GYM	40 m ²
FAMILY	34 m ²
GUEST BEDROOM	34 m ²
LIVING	34 m ²
FOYER	31 m ²
DINING	28 m ²
BATH	24 m ²
OFFICE	23 m ²
BUTLER'S ROOM	21 m ²
CINEMA	20 m ²
ENT. LOBBY	18 m ²
SERVICE CORRIDOR	17 m ²
FRONT KITCHEN	14 m ²
SALON	13 m ²
BACK KITCHEN	11 m ²
DRESS	7 m ²
LOBBY	5 m ²
LOBBY	5 m ²
BATH	4 m ²
LAUN.	4 m ²
PWDR	3 m ²
WASH	3 m ²

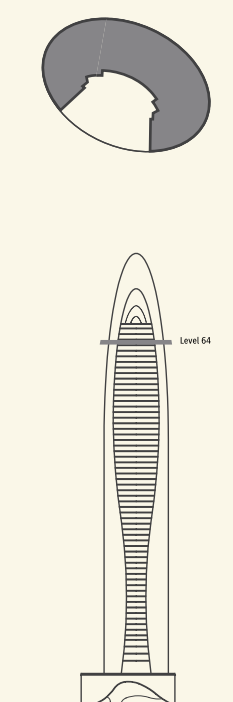

Disclaimer: 1. All stated dimensions and services whether in relation to the building, common areas or individual units are subject to government and local authority approvals. Final dimensions and services will be stated in your sales and purchase agreement 2. All room dimensions are measured to structural elements and exclude wall finishes and construction tolerances. 3. All dimensions have been provided by our consultant architects. 4. All materials, dimensions and drawings are approximate. Information is subject to change without notice. 5. Actual suite area may vary from the stated area. Drawings are not to scale. The Developer reserves the right to make any revisions whatsoever including for aesthetic purposes.

6. Calculation of suite area is measured as the area bounded by the centre line of demising or partition walls separating one unit from another unit, the exterior face of all exterior walls, and the exterior face of the corridor wall enclosing the adjoining unit. 7. Calculation of balcony area is measured as the area bounded by the centre line of demising or partition walls separating one unit from another unit, the outmost face of the enclosing guard and the external face of the adjoining balcony. 8. The units are measured at typical floor in the building. Columns may vary in size depending on the floor level. 9. For each unit type, unit sizes and details might be different and your sales and purchase agreement will contain the actual size of each specific unit.

The Mercedes-Benz Uhlenhaut Coupé Penthouse

The Triplex Penthouse | Level 1
Isometric View



- 1 LIVING LOUNGE
- 2 DINNING
- 3 FAMILY
- 4 FOYER
- 5 OFFICE
- 6 GUESS BEDROOM
- 7 BATHROOM SUITE
- 8 WALK-IN CLOSET
- 9 ENT LOBBY
- 10 BACK KITCHEN
- 11 WC
- 12 FRONT KITCHEN
- 13 CINEMA
- 14 BUTLERS ROOM
- 15 WC
- 16 LAUND
- 17 SALON
- 18 GYM
- 19 BALCONY
- 20 SWIMMING POOL

The Mercedes-Benz Uhlenhaut Coupé Penthouse

The Triplex Penthouse | Level 2

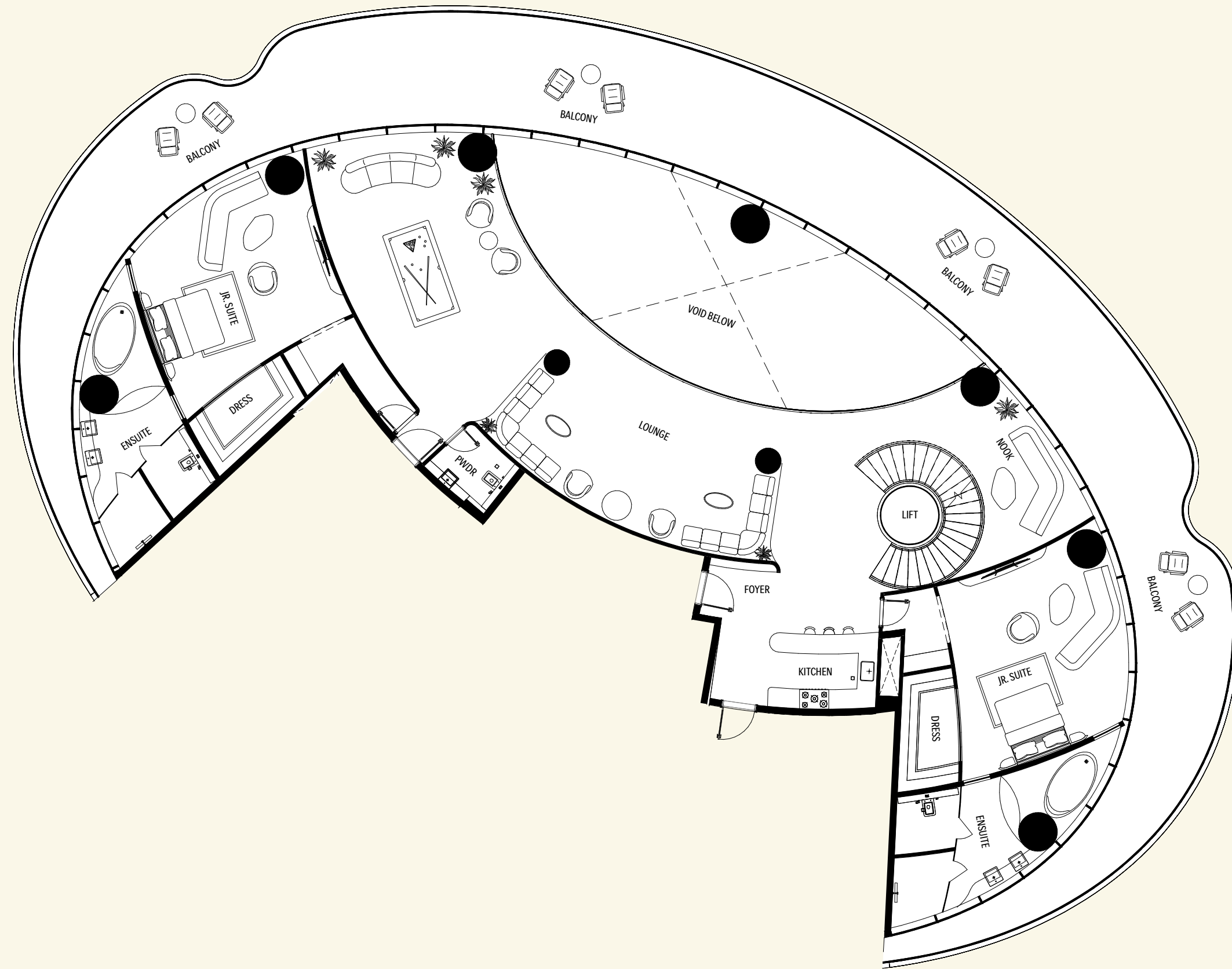

AREA	SQ.M	SQ.FT
Suite Area	324 m ²	3483 ft ²
Balcony Area	191 m ²	2055 ft ²
Total Unit Area	515 m ²	5538 ft ²

FLAT DESIGN COMPONENTS	
LOUNGE	91 m ²
NOOK	50 m ²
JR. SUITE	39 m ²
JR. SUITE	37 m ²
ENSUITE	22 m ²
ENSUITE	22 m ²
LOBBY	12 m ²
FOYER	9 m ²
KITCHEN	8 m ²
DRESS	6 m ²
DRESS	6 m ²
PWDR	4 m ²

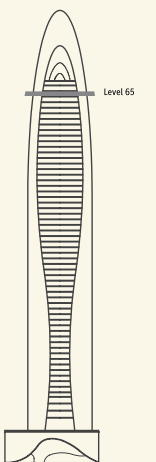
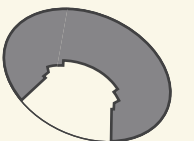

Disclaimer: 1. All stated dimensions and services whether in relation to the building, common areas or individual units are subject to government and local authority approvals. Final dimensions and services will be stated in your sales and purchase agreement 2. All room dimensions are measured to structural elements and exclude wall finishes and construction tolerances. 3. All dimensions have been provided by our consultant architects. 4. All materials, dimensions and drawings are approximate. Information is subject to change without notice. 5. Actual suite area may vary from the stated area. Drawings are not to scale. The Developer reserves the right to make any revisions whatsoever including for aesthetic purposes.

6. Calculation of suite area is measured as the area bounded by the centre line of demising or partition walls separating one unit from another unit, the exterior face of all exterior walls, and the exterior face of the corridor wall enclosing the adjoining unit. 7. Calculation of balcony area is measured as the area bounded by the centre line of demising or partition walls separating one unit from another unit, the outmost face of the enclosing guard and the external face of the adjoining balcony. 8. The units are measured at typical floor in the building. Columns may vary in size depending on the floor level. 9. For each unit type, unit sizes and details might be different and your sales and purchase agreement will contain the actual size of each specific unit.

The Mercedes-Benz Uhlenhaut Coupé Penthouse

The Triplex Penthouse | Level 2
Isometric View



- 1 LOUNGE
- 2 LIFT
- 3 FOYER
- 4 KITCHEN
- 5 NOOK
- 6 JR. SUITE
- 7 WALK-IN CLOSET
- 8 ENSUITE
- 9 WC
- 10 WALK-IN CLOSET
- 11 ENSUITE
- 12 JR. SUITE
- 13 BALCONY

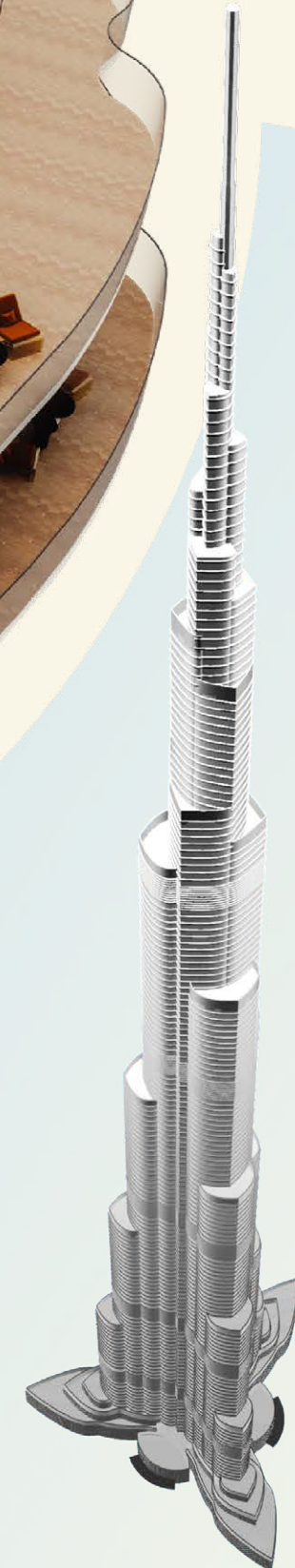

The Mercedes-Benz Uhlenhaut Coupé Penthouse

The Triplex Penthouse | Level 3

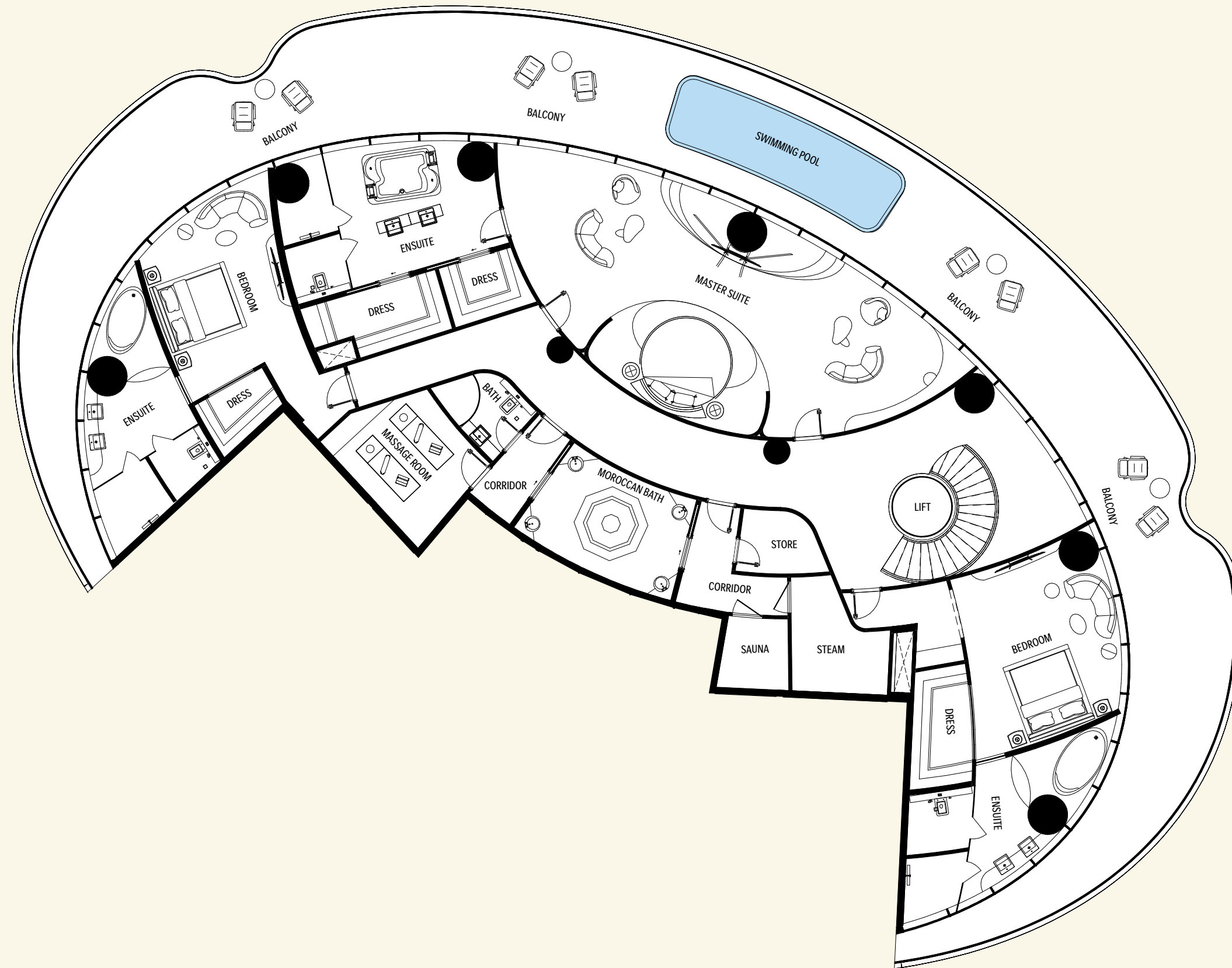

AREA	SQ.M	SQ.FT
Suite Area	195 m ²	2104 ft ²
Balcony Area	374 m ²	4023 ft ²
Total Unit Area	569 m ²	6126 ft ²

FLAT DESIGN COMPONENTS	
MASTER SUITE	76 m ²
LOBBY	60 m ²
BEDROOM	31 m ²
BEDROOM	26 m ²
ENSUITE	25 m ²
BATH	20 m ²
BATH	20 m ²
MOROCCAN BATH	15 m ²
MASSAGE ROOM	13 m ²
STEAM	8 m ²
DRESS	7 m ²
CORRIDOR	6 m ²
DRESS	6 m ²
BATH	5 m ²
CORRIDOR	4 m ²
DRESS	4 m ²
DRESS	4 m ²
SAUNA	4 m ²
STORE	4 m ²

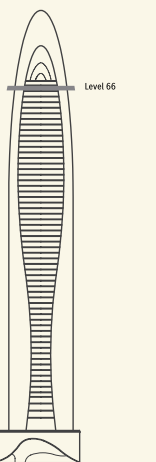
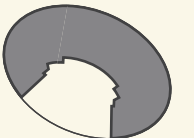

Disclaimer: 1. All stated dimensions and services whether in relation to the building, common areas or individual units are subject to government and local authority approvals. Final dimensions and services will be stated in your sales and purchase agreement 2. All room dimensions are measured to structural elements and exclude wall finishes and construction tolerances. 3. All dimensions have been provided by our consultant architects. 4. All materials, dimensions and drawings are approximate. Information is subject to change without notice. 5. Actual suite area may vary from the stated area. Drawings are not to scale. The Developer reserves the right to make any revisions whatsoever including for aesthetic purposes.

6. Calculation of suite area is measured as the area bounded by the centre line of demising or partition walls separating one unit from another unit, the exterior face of all exterior walls, and the exterior face of the corridor wall enclosing the adjoining unit. 7. Calculation of balcony area is measured as the area bounded by the centre line of demising or partition walls separating one unit from another unit, the outmost face of the enclosing guard and the external face of the adjoining balcony. 8. The units are measured at typical floor in the building. Columns may vary in size depending on the floor level. 9. For each unit type, unit sizes and details might be different and your sales and purchase agreement will contain the actual size of each specific unit.

The Mercedes-Benz Uhlenhaut Coupé Penthouse

The Triplex Penthouse | Level 3
Isometric View



- 1 MASTER BEDROOM
- 2 LIFT
- 3 BEDROOM
- 4 ENSUITE
- 5 WALK-IN CLOSET
- 6 STEAM
- 7 SAUNA
- 8 CORRIDOR
- 9 MOROCCAN BATH
- 10 MASSAGE ROOM
- 11 BATHROOM SUITE
- 12 ENSUITE
- 13 BEDROOM
- 14 ENSUITE
- 15 BALCONY

This is

Mercedes-Benz Places

BINGHATTI

born from tomorrow