

ONE  
RIVER POINT



BUSINESS BAY

# ONE RIVER POINT

Crafted and curated with the design connoisseur in mind, One River Point is Ellington and Dutco's latest arrival in Business Bay. Located on the southwest side, its vast triangular plot faces Dubai Water Canal to the north. In addition to a wealth of sumptuous amenities, the building offers studios, one, two, and three bedroom apartments, as well as duplexes and penthouse suites.

The atmosphere inside is soft, contemporary, and welcoming, with low lighting that emulates a calm return from the vitality that keeps Business Bay one of Dubai's most eclectic and inspiring locations.



BUSINESS BAY'S MOST  
ECLECTIC LIFESTYLE





 ELLINGTON | **DUTCO**

Ellington Properties and Dutco are bringing together a wealth of experience and expertise in the development of One River Point.

Combining Ellington's resident-first philosophy with the attention to detail and efficiency for which Dutco is renowned, we can achieve perfection with speed. Our partnership marks a new era of growth for Ellington, and the rapid expansion of Dubai.



## THE RHYTHM OF THE CITY

Business Bay has long held a reputation for being home to a vibrant community of innovation and aspiration. It has since attracted a wealth of exciting venues for dining, art culture, and socialising.

With its canalside spaces, collection of fitness amenities, and, of course, close connection to Downtown Dubai, residents of One River Point take full advantage of Dubai's wealth of opportunities.



CANALSIDE COSMOPOLITAN  
WITH DUBAI WATER CANAL VIEWS



Dubai Water Canal Boardwalk	<b>1 minute</b>
Dubai Waterfall	<b>2 minutes</b>
Business Bay Metro Station Business Bay Marina Al Quoz Pond Park	<b>5 minutes</b>
Burj Khalifa Dubai Mall	<b>7 minutes</b>
Museum of The Future	<b>8 minutes</b>
Dubai International Financial Centre City Walk Meydan Racecourse	<b>10 minutes</b>
Mall of the Emirates	<b>13 minutes</b>
Dubai Design District Dubai Festival City Kite Beach	<b>15 minutes</b>
Burj Al Arab	<b>17 minutes</b>
Palm Jumeirah	<b>19 minutes</b>
Emirates Golf Club Dubai International Airport	<b>20 minutes</b>
Al Maktoum International Airport	<b>39 minutes</b>

## DRIVING DISTANCES







## MAKE AN ENTRANCE

Returning home via one of the area's cycle routes, by car, or via taxi using the hotel-style drop-off area with concierge service, the entrance lobby at One River Point is always a warm welcome. A bright and active space, the lobby is centred on beautiful marble flooring.







SOPHISTICATION  
WITH AN EDGE

## WHERE STYLE MEETS CHARACTER

Refined in its detailing and expressive in its tone, One River Point creates the warmth of home and amplifies modern life at its most beautiful.

Contemporary aesthetics, cutting-edge technology, and a prime location connect residents to a lifestyle that crosses paths, creates opportunities, and revitalises wellbeing. The entire building, inside and out is created to help its residents flourish in their new home.

The presence of local artists adds to this positive influence, with their works on display throughout the corridors.



## SEAMLESS FLOW

With sparkling canals on either side, the podium marks the base of One River Point, the triangular structure from which the property gets its name.

The podium marks a confidence that means to go on, housing a pool and decking area on its roof before the tower extends upwards in exquisite architectural layers.

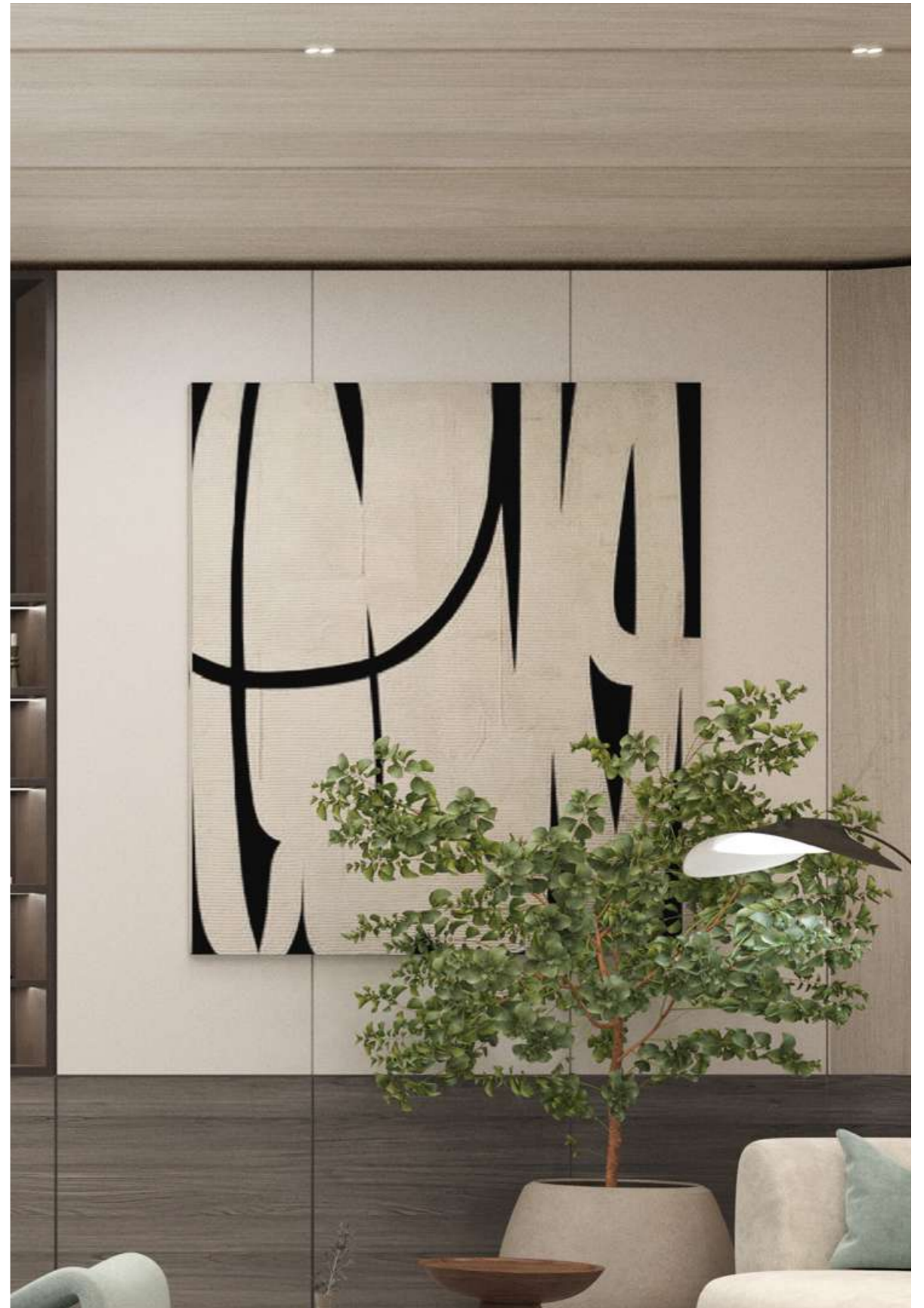



## THE RIVER CLUB

Balanced on the outermost point of The Podium, the pool deck at One River Point provides a shaded terrace, family and adult infinity pools, BBQ areas and sun-loungers.

It is the ideal place for watching the sun go down over the canal, elevated, sophisticated and relaxing, The River Club is already set to be a favourite of One River Point residents.



FLOW AND DYNAMISM







## THE CLUBHOUSE

A refined interiors palette invites you to a sophisticated shared space. Formal yet dynamic, the Clubhouse sits on the upper floor of The Podium, overlooking the swimming pool through large glass doors.

Opening into an elegant lounge space, with sumptuous furnishings, co-working spaces, a coffee station and pantry, it is an ideal meeting spot to inspire your next idea.



## KID'S PLAY AREAS

Children at One River Point are encouraged to learn, play and explore among the property's dynamic spaces. Indoors, children have access to interactive toys and games, as well as children's furniture, bathrooms and baby change.

The Podium features a playground equipped with soft features and high-end play equipment, and, for poolside fun, there is a dedicated kids' splash play area for endless entertainment.



INDOOR AND OUTDOOR  
ADVENTURES





## IMMERSIVE ROOM

Enter a zone of contemplation and find a moment away from your busy life. In this unique experience at One River Point, residents can immerse themselves in a portal-like experience. The room instills a calming presence straight away, as you lie on one of the day beds strategically placed around the room, a multi-projector display fills the space with beautiful patterns and textures.



## FITNESS CENTER

Designed to help One River Point residents achieve balance, the fitness centre creates space for workouts, stretches and mindfulness practices. The layout is professionally certified and equipped with high-end equipment, a climbing net, as well as spa-like showers and changing rooms.

There is also an interactive yoga screen and studio overlooking the pool terrace.



VITALITY THROUGH DESIGN







## YOGA STUDIO

The yoga studio serves as a haven for well-being, with a thoughtful design that aims to foster a deeper connection between the body, mind, and the natural beauty outside its windows. The ambiance is intentionally calming, with a focus on the mesmerizing canal views.

To boost both functionality and visual appeal, sturdy wooden flooring provides a stable and comfortable foundation for yoga practice, ensuring a secure experience for everyone. Additionally, a cutting-edge virtual trainer is projected onto the wall, guiding participants through their yoga sessions with expert guidance and precision.



## THE RESIDENCES

One River Point is tailored to a range of lifestyles, offering a beautifully designed collection of studios, apartments, four-bedroom duplexes, and decadent penthouses with private swimming pools. While different in their character, every home at One River Point encapsulates style and quality, down to the last detail.



DESIGNED WITH  
PERSONALITY





## LIVING SPACES

Clean design and contemporary floor plans create a playful dynamic between floods of natural light and shadow. This interplay is the result of expansive windows softening darker tones and illuminating the space. High ceilings and expansive balconies draw on this interplay, bringing about a unique yet sophisticated personality in every home.



## THE KITCHENS

Floor-to-ceiling windows allow natural light to fill the modern kitchens of One River Point. Contrasting with the black accents and elevating the neutral colour palette, the light brings out an edge of sophistication surrounding the ingenious storage solutions, appliances, and integrated spaces. At the centre, a grand kitchen island draws the family to a space for enjoying quality time together, over food, social occasions, and coffee.

Specifically selected for 3-bedroom apartments, Duplexes and Penthouses, are a bespoke collection of extra kitchen appliances. This includes an integrated waterfall drop-in sink, in a sleek and contemporary gunmetal grey, featuring rainfall and pull-out faucets, a cup washer, drain control, chopping board, and drain basket. Additionally, our most exclusive kitchens will feature an integrated energy-efficient Teka Downdraft Hood Slider with touch control settings and charcoal filter.



IMBUED WITH  
THE WARMTH OF HOME







## **BATHROOMS & POWDER ROOMS**

Fresh and functional, with warm finishes and intricately applied detailing set the scene for self-care and relaxing cleansing rituals. While, behind the scenes, subtle ambient lighting, ample hidden storage, and a generous rain shower allow for seamless daily routines.



# FLOOR PLANS

# STUDIO

TYPE A

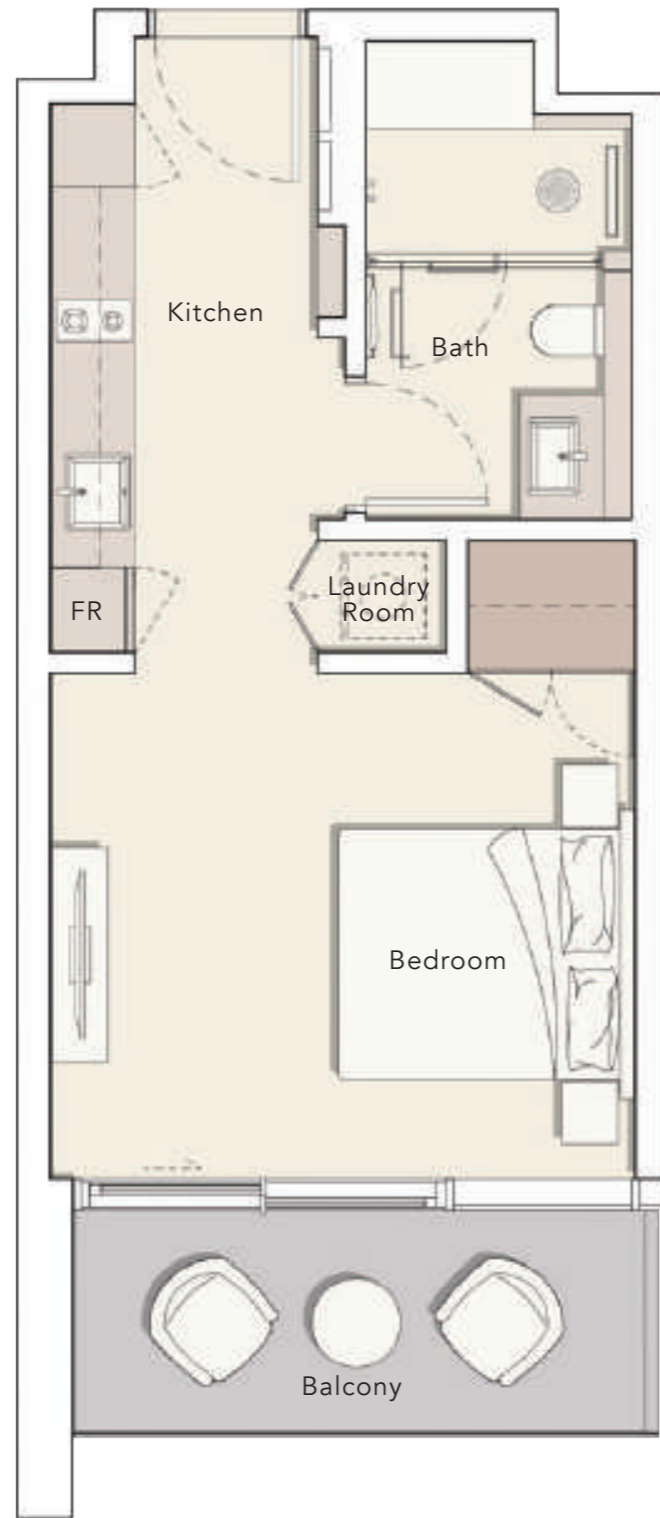

Internal Living Area : **401.06 Sq. Ft**  
Outdoor Living Area : **86.43 Sq. Ft**  
Total Living Area : **487.50 Sq. Ft**

18<sup>th</sup> - 36<sup>th</sup> FLOOR

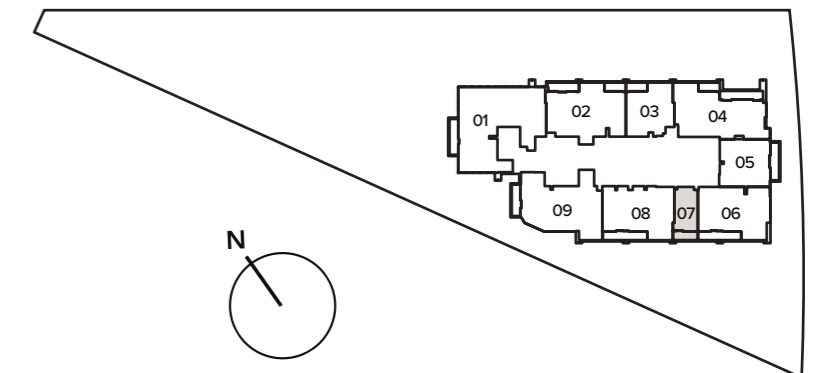

# 1 BEDROOM

TYPE A

Internal Living Area : 886.41 Sq. Ft  
Outdoor Living Area : 71.69 Sq. Ft  
Total Living Area : 958.10 Sq. Ft



**3<sup>rd</sup> FLOOR**

301

**7<sup>th</sup> FLOOR**

701

**4<sup>th</sup> FLOOR**

401

**8<sup>th</sup> - 16<sup>th</sup> FLOOR**

803

**5<sup>th</sup> FLOOR**

501

**18<sup>th</sup> - 36<sup>th</sup> FLOOR**

1803

**6<sup>th</sup> FLOOR**

601

**8<sup>th</sup> - 16<sup>th</sup> FLOOR**

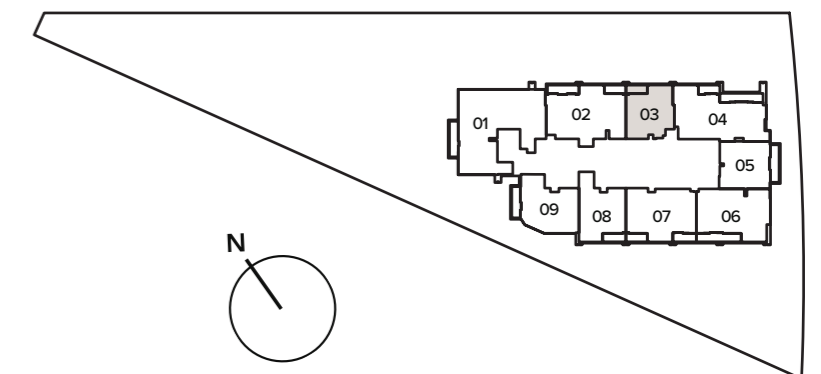

# 1 BEDROOM

TYPE B

Internal Living Area : 930.43 Sq. Ft  
Outdoor Living Area : 129.81 Sq. Ft  
Total Living Area : 1060.25 Sq. Ft

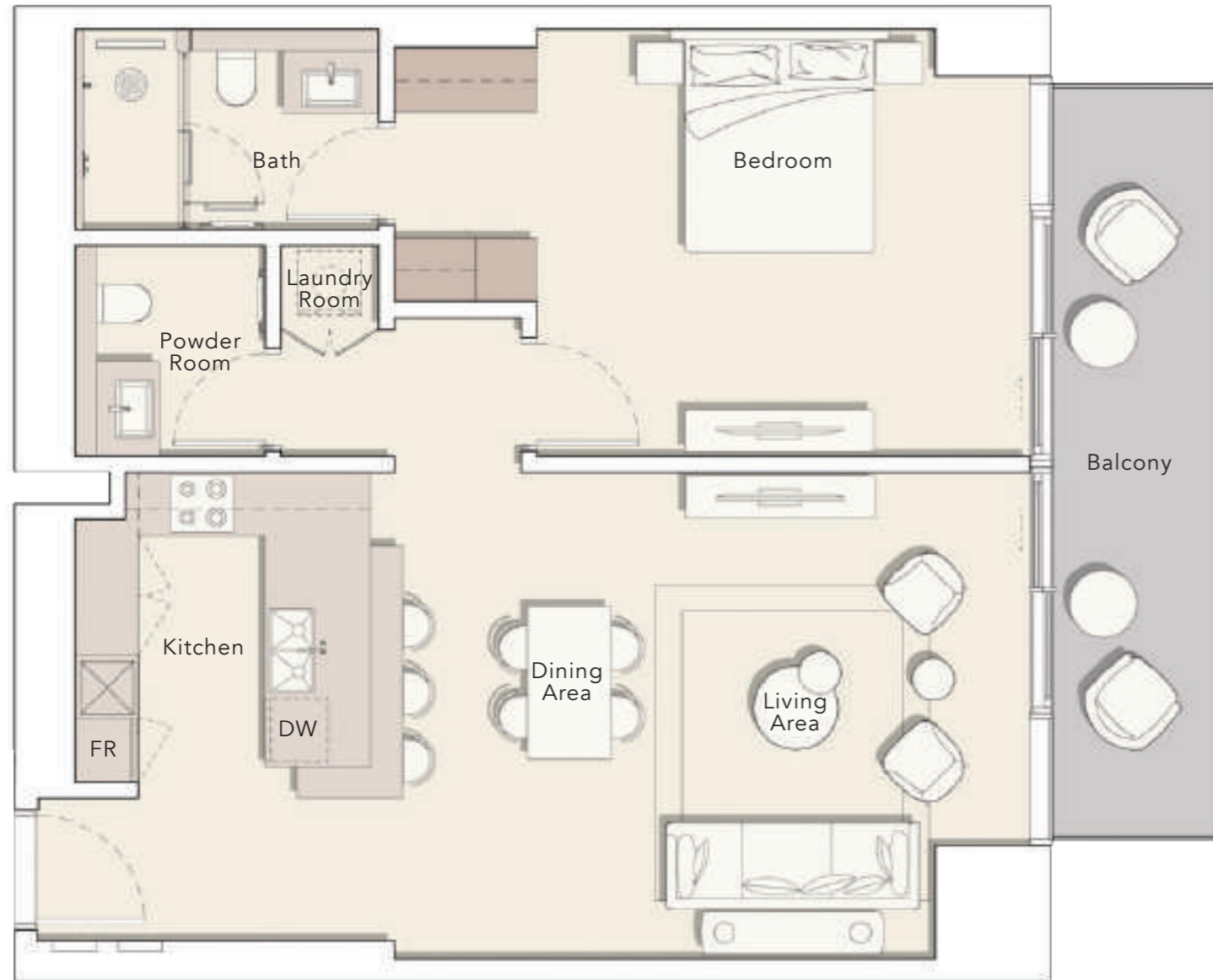

**3<sup>rd</sup> FLOOR**

303

**7<sup>th</sup> FLOOR**

703

**4<sup>th</sup> FLOOR**

403

**8<sup>th</sup> - 16<sup>th</sup> FLOOR**

805

**5<sup>th</sup> FLOOR**

503

**18<sup>th</sup> - 36<sup>th</sup> FLOOR**

1805

**6<sup>th</sup> FLOOR**

603

**8<sup>th</sup> - 16<sup>th</sup> FLOOR**

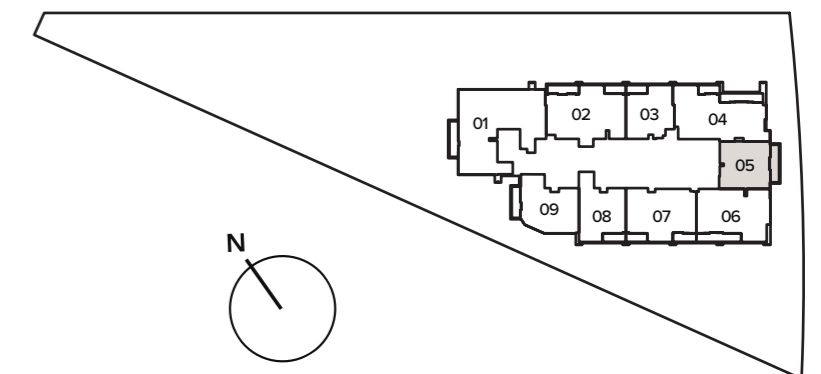

# 1 BEDROOM

TYPE C

Internal Living Area : 1090.49 Sq. Ft  
Outdoor Living Area : 107.10 Sq. Ft  
Total Living Area : 1197.59 Sq. Ft

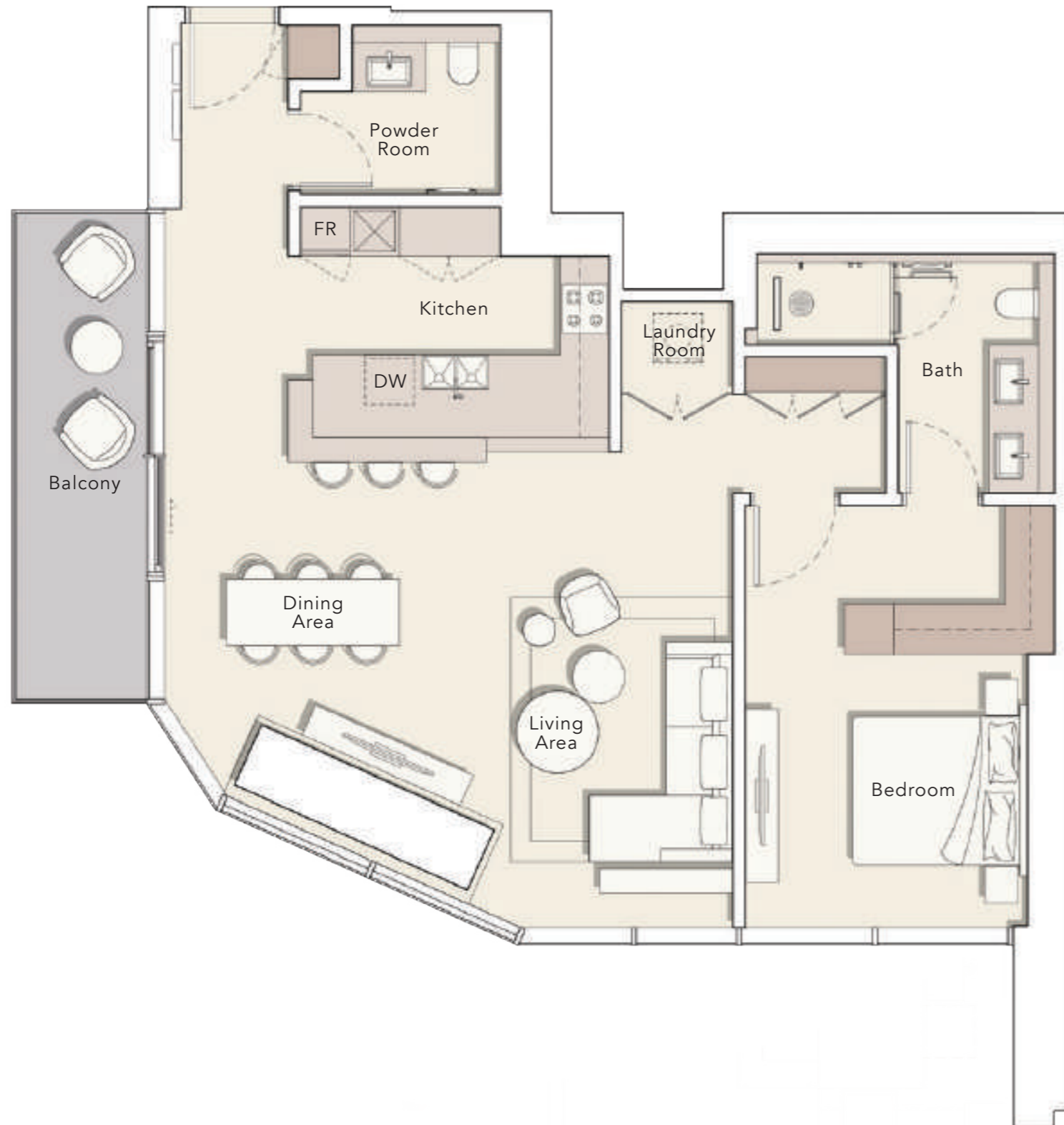

**3<sup>rd</sup> FLOOR**

307

**7<sup>th</sup> FLOOR**

707

**4<sup>th</sup> FLOOR**

407

**8<sup>th</sup> - 16<sup>th</sup> FLOOR**

809

**5<sup>th</sup> FLOOR**

507

**6<sup>th</sup> FLOOR**

607

**8<sup>th</sup> - 16<sup>th</sup> FLOOR**

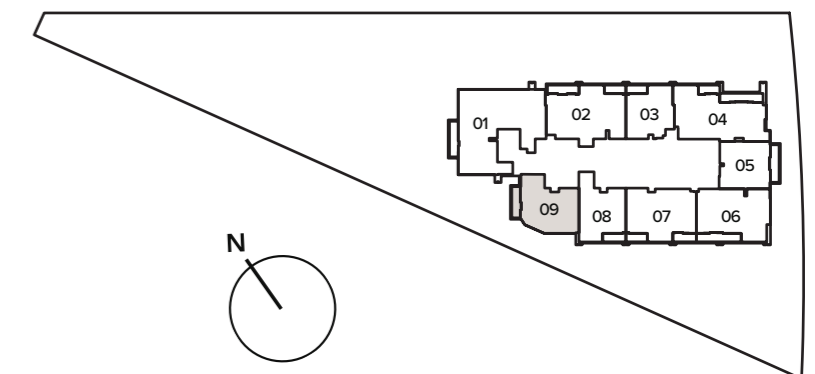

# 1 B E D R O O M

T Y P E D

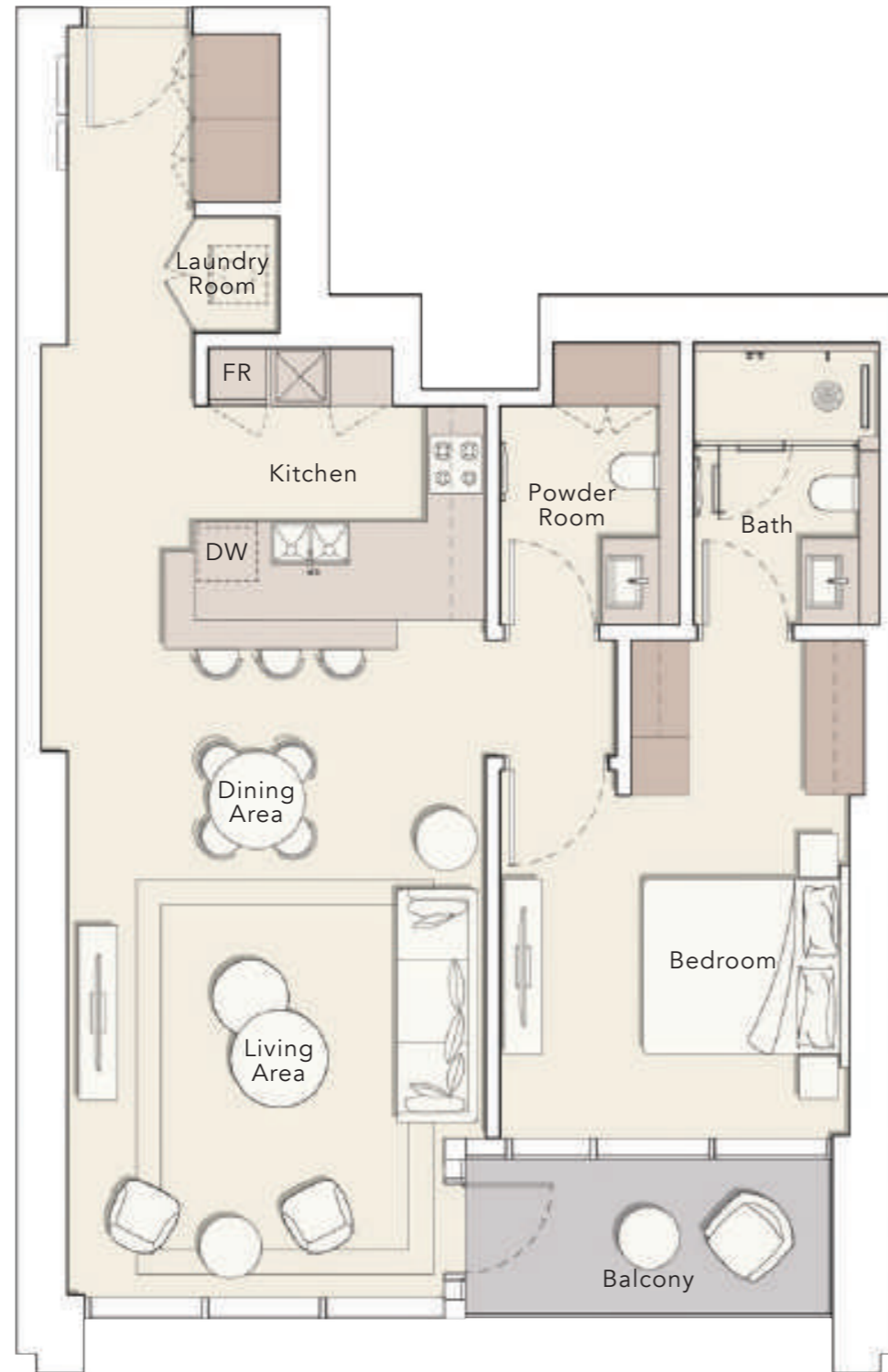

Internal Living Area : 991.03 Sq. Ft  
Outdoor Living Area : 77.82 Sq. Ft  
Total Living Area : 1068.86 Sq. Ft

**3<sup>rd</sup> FLOOR**

306

**7<sup>th</sup> FLOOR**

706

**4<sup>th</sup> FLOOR**

406

**8<sup>th</sup> - 16<sup>th</sup> FLOOR**

808

**5<sup>th</sup> FLOOR**

506

**6<sup>th</sup> FLOOR**

606

**8<sup>th</sup> - 16<sup>th</sup> FLOOR**

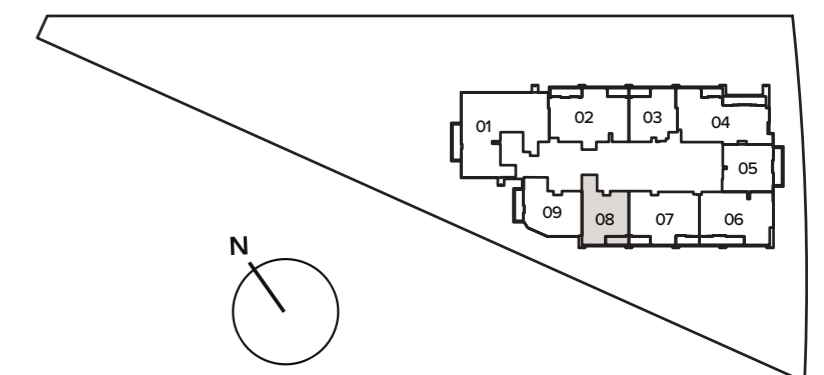



# 2 BEDROOM

TYPE A

Internal Living Area : 1337.31 Sq. Ft  
Outdoor Living Area : 152.63 Sq. Ft  
Total Living Area : 1489.94 Sq. Ft

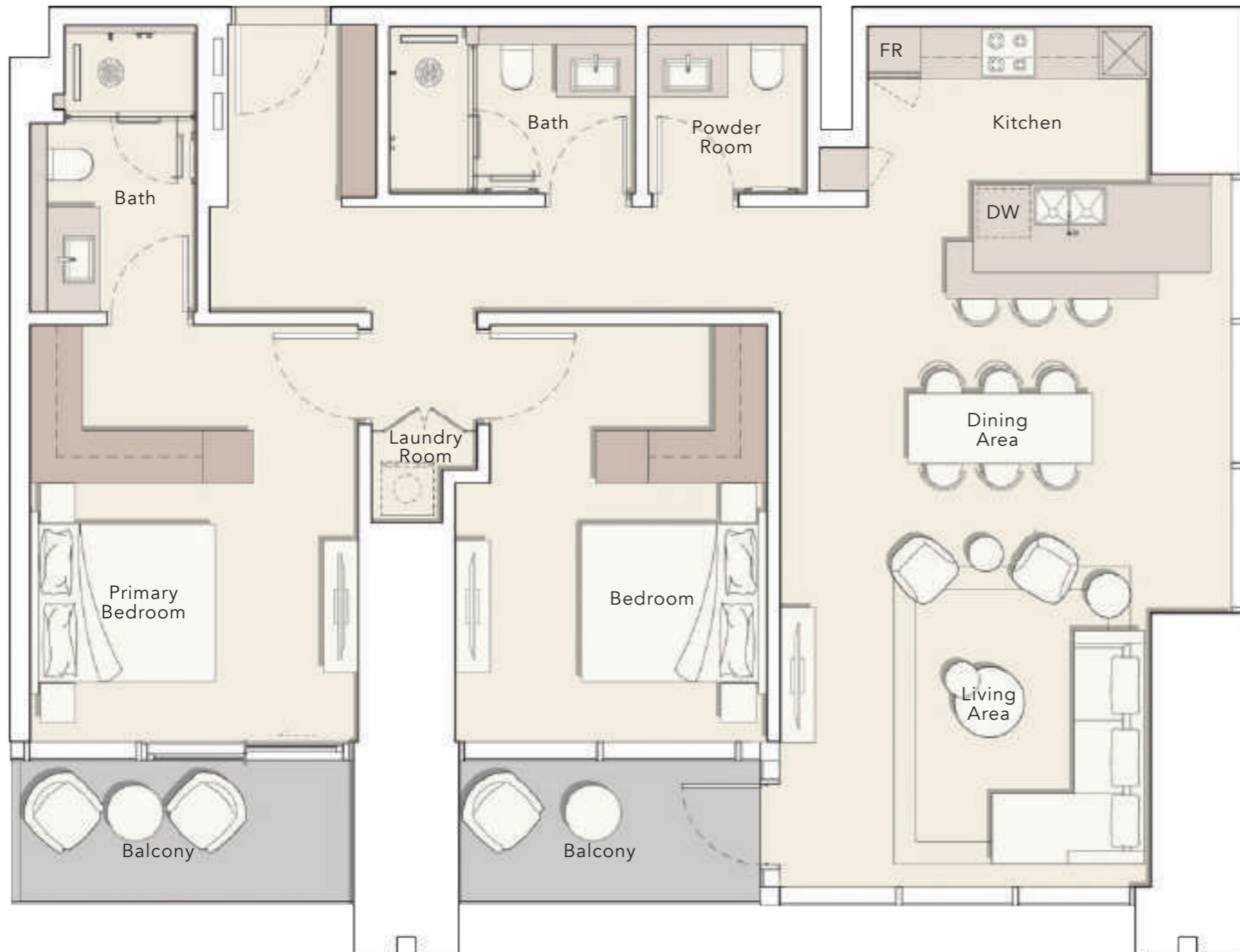

**3<sup>rd</sup> FLOOR**

304

**7<sup>th</sup> FLOOR**

704

**4<sup>th</sup> FLOOR**

404

**8<sup>th</sup> - 16<sup>th</sup> FLOOR**

806

**5<sup>th</sup> FLOOR**

504

**18<sup>th</sup> - 36<sup>th</sup> FLOOR**

1806

**6<sup>th</sup> FLOOR**

604

**8<sup>th</sup> - 16<sup>th</sup> FLOOR**

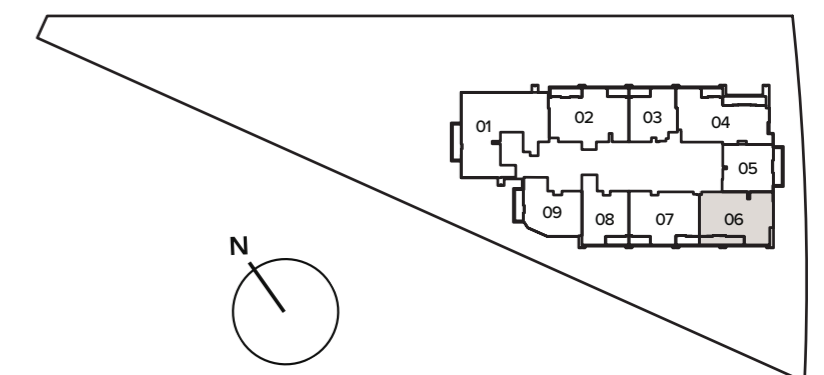

# 2 BEDROOM

TYPE B

Internal Living Area : 1295.22 Sq. Ft

Outdoor Living Area : 152.63 Sq. Ft

Total Living Area : 1447.85 Sq. Ft

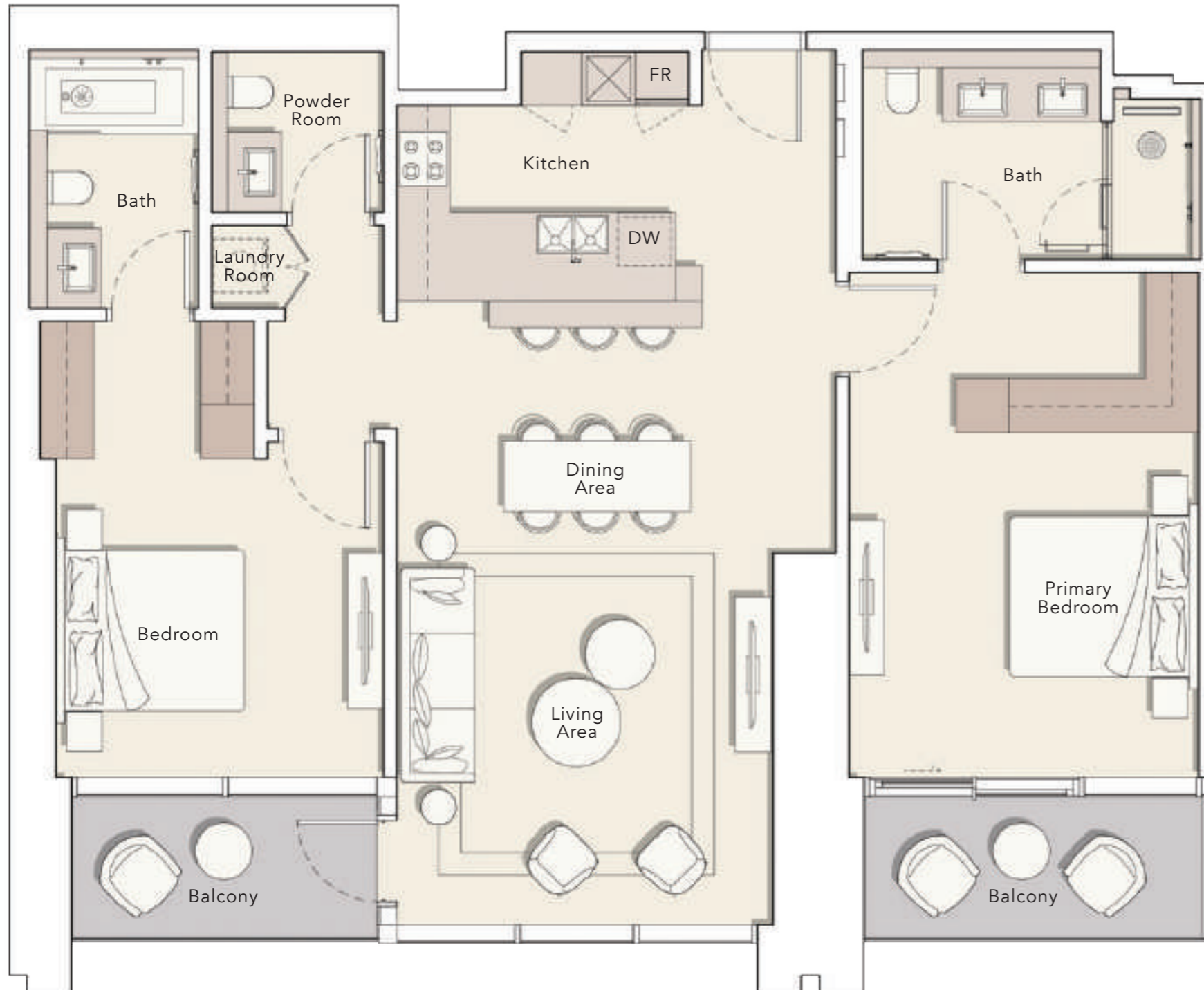

**3<sup>rd</sup> FLOOR**

305

**7<sup>th</sup> FLOOR**

705

**4<sup>th</sup> FLOOR**

405

**8<sup>th</sup> - 16<sup>th</sup> FLOOR**

807

**5<sup>th</sup> FLOOR**

505

**6<sup>th</sup> FLOOR**

605

**8<sup>th</sup> - 16<sup>th</sup> FLOOR**

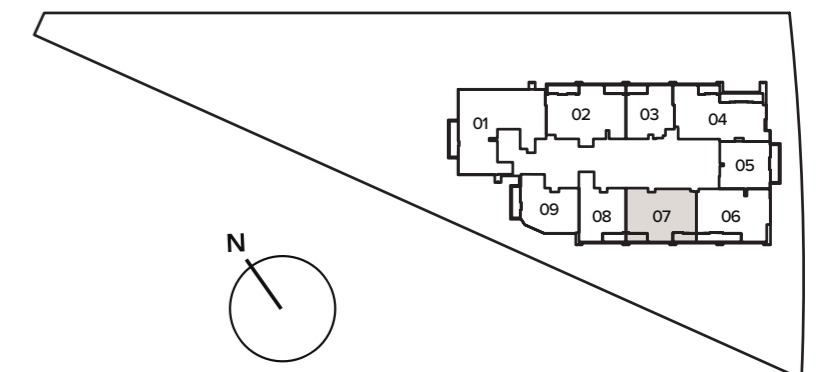

# 2 BEDROOM

TYPE C

Internal Living Area : 1328.48 Sq. Ft

Outdoor Living Area : 151.77 Sq. Ft

Total Living Area : 1480.25 Sq. Ft

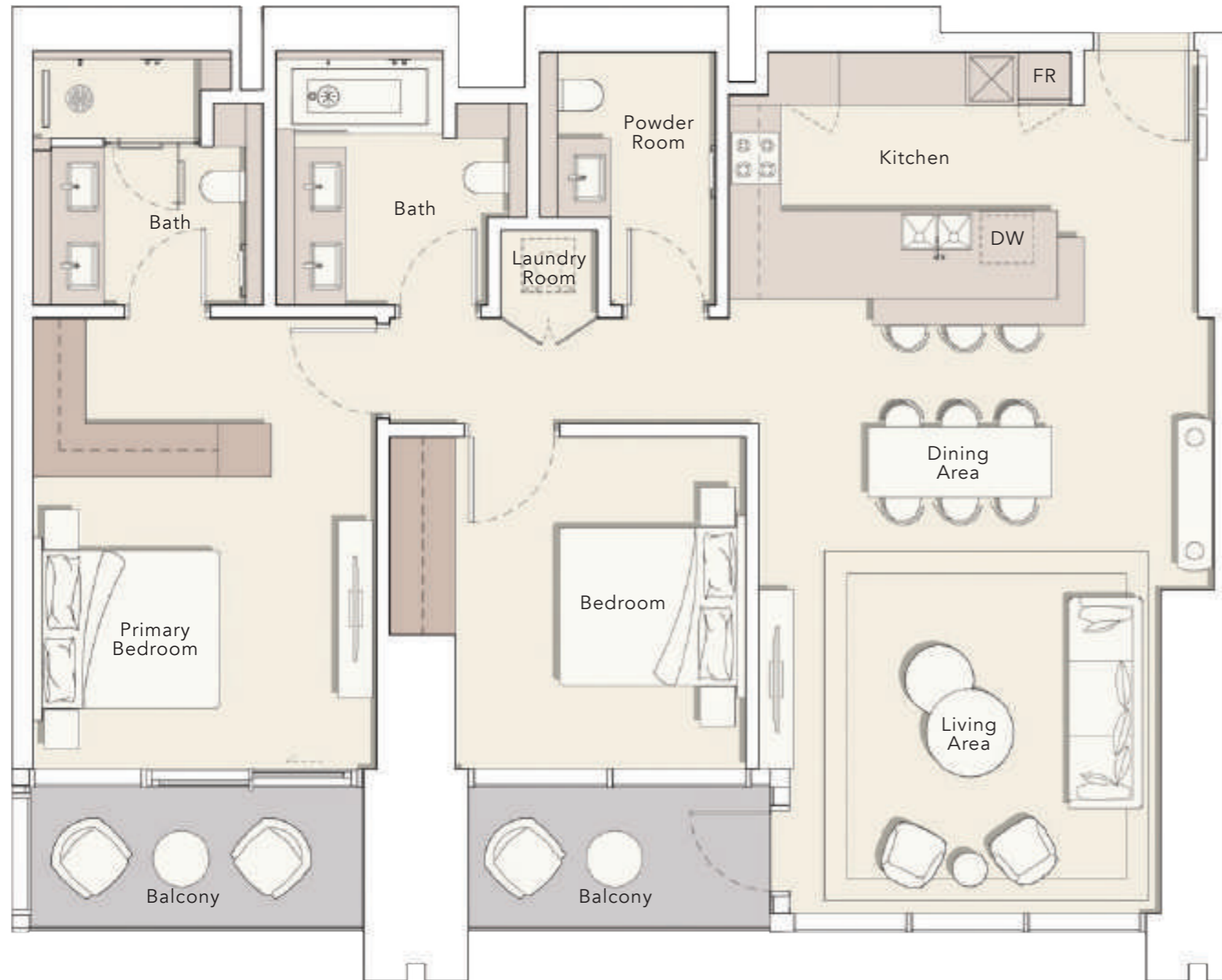

18<sup>th</sup> - 36<sup>th</sup> FLOOR

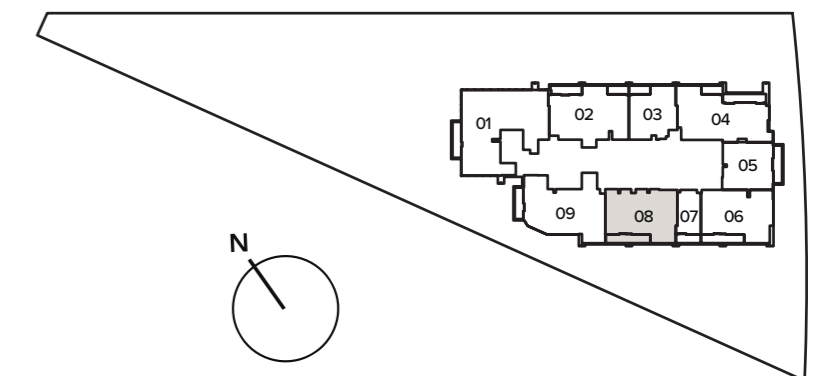

# 2 BEDROOM + S

TYPE A

Internal Living Area : 1573.04 Sq. Ft  
Outdoor Living Area : 222.92 Sq. Ft  
Total Living Area : 1795.96 Sq. Ft

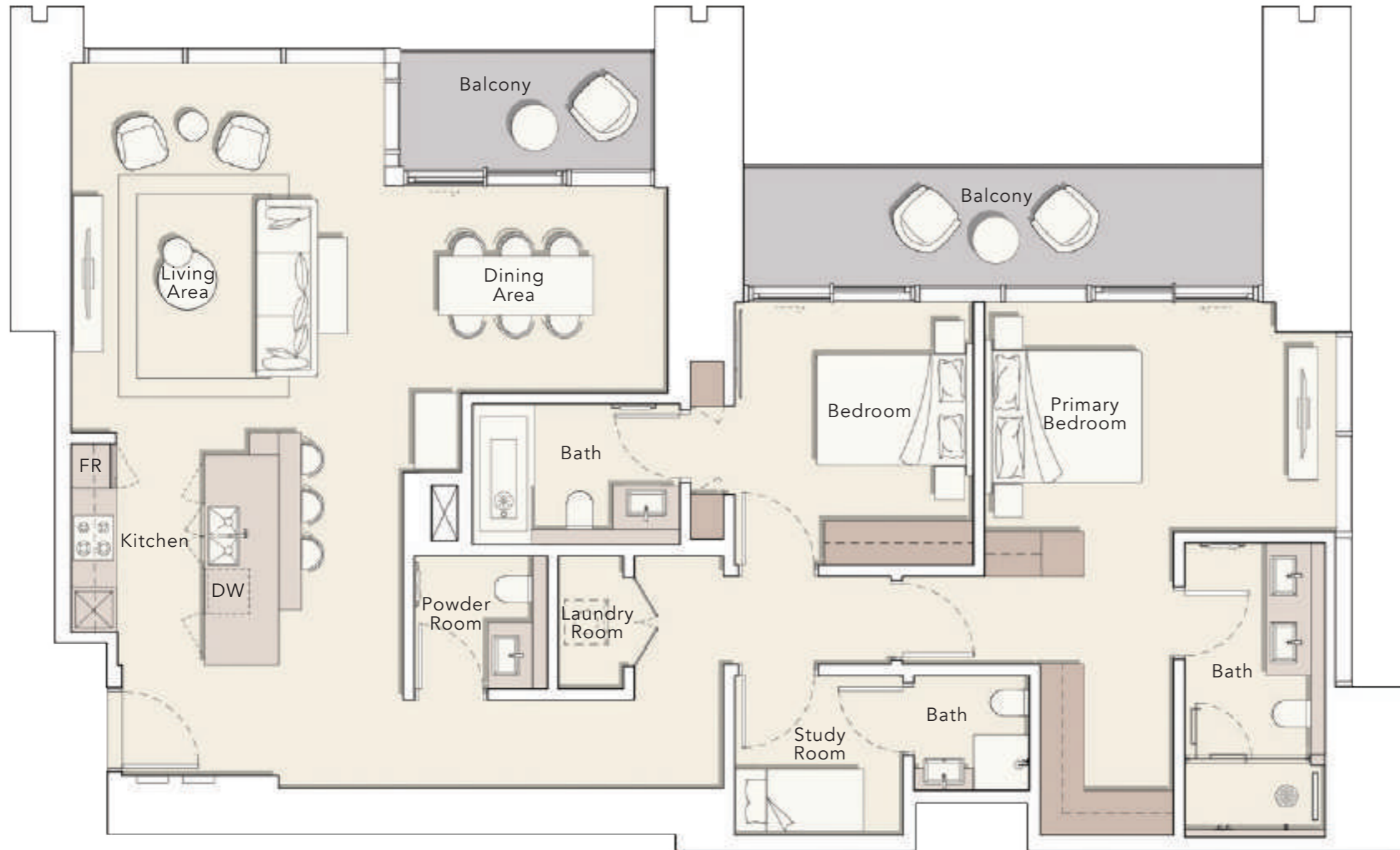

**3<sup>rd</sup> FLOOR**

302

**7<sup>th</sup> FLOOR**

702

**4<sup>th</sup> FLOOR**

402

**8<sup>th</sup> - 16<sup>th</sup> FLOOR**

804

**5<sup>th</sup> FLOOR**

502

**18<sup>th</sup> - 36<sup>th</sup> FLOOR**

1804

**6<sup>th</sup> FLOOR**

602

**8<sup>th</sup> - 16<sup>th</sup> FLOOR**

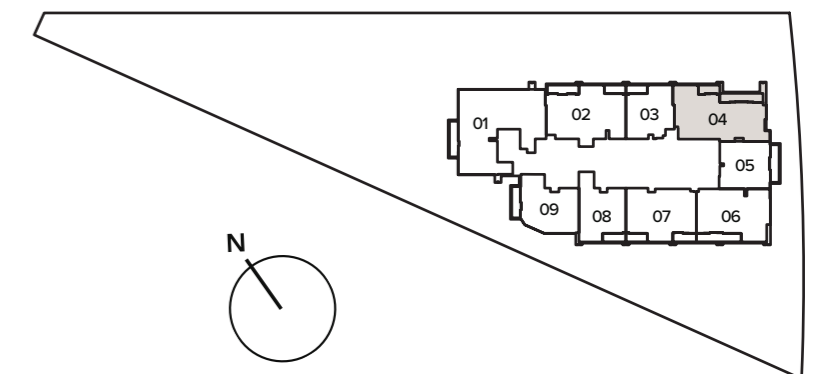

# 2 BEDROOM + S

TYPE B

Internal Living Area : 1509.53 Sq. Ft  
Outdoor Living Area : 178.79 Sq. Ft  
Total Living Area : 1688.32 Sq. Ft

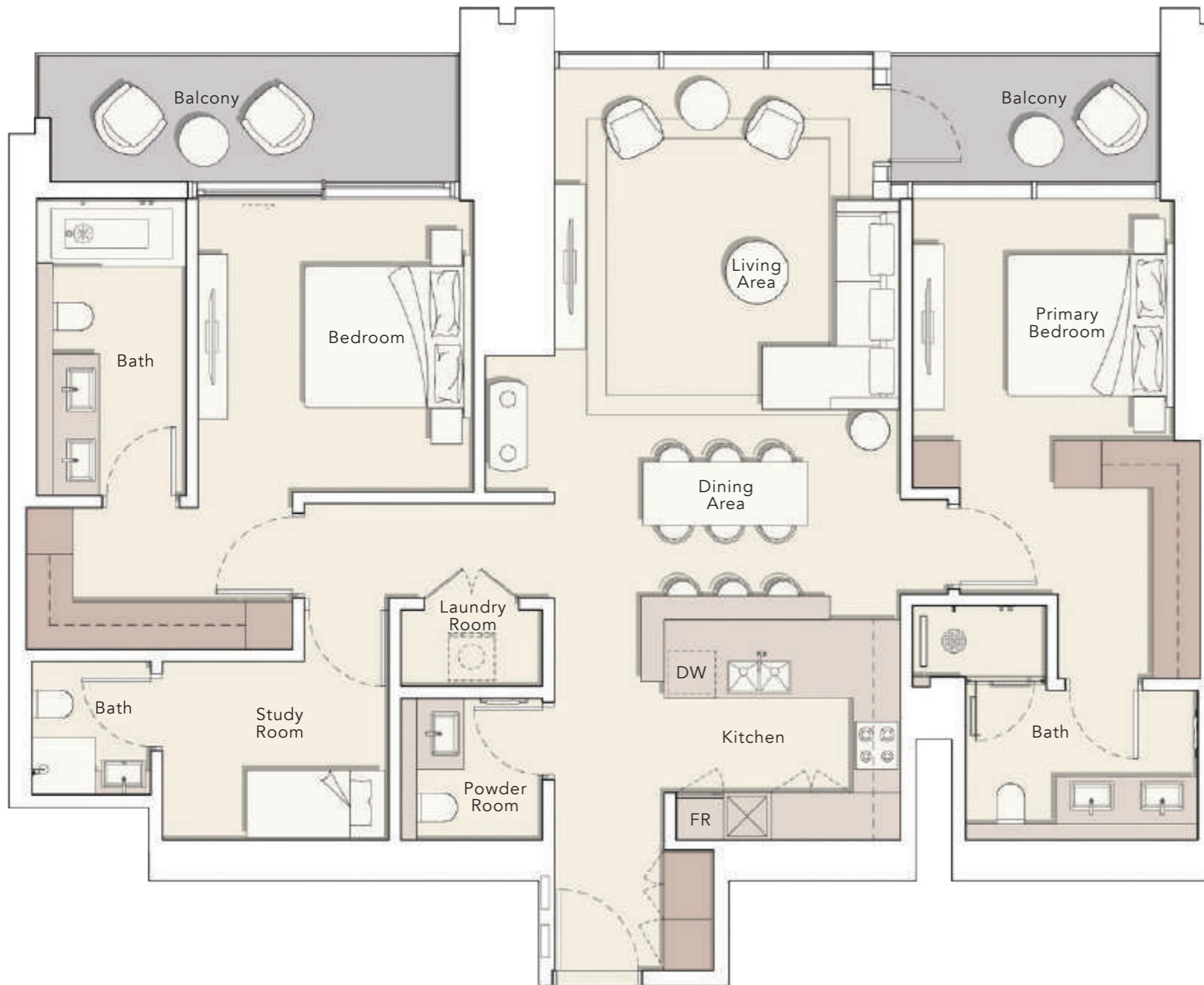

**8<sup>th</sup> - 16<sup>th</sup> FLOOR**

802

**18<sup>th</sup> - 36<sup>th</sup> FLOOR**

1802

**8<sup>th</sup> - 16<sup>th</sup> FLOOR**

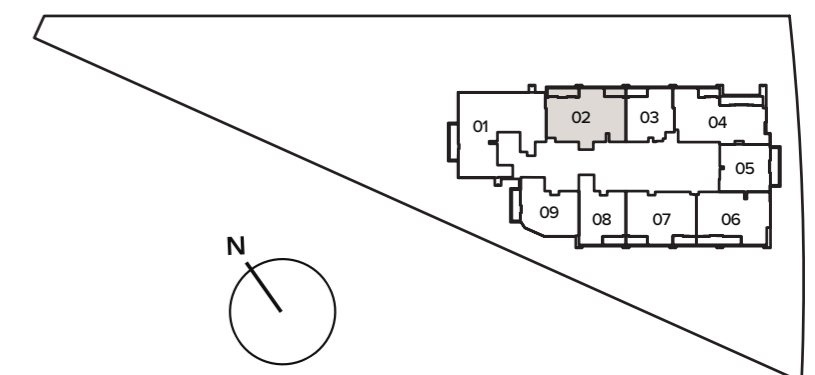

# 2 BEDROOM + S

TYPE C

Internal Living Area : 1678.20 Sq. Ft

Outdoor Living Area : 107.10 Sq. Ft

Total Living Area : 1785.30 Sq. Ft



18<sup>th</sup> - 36<sup>th</sup> FLOOR

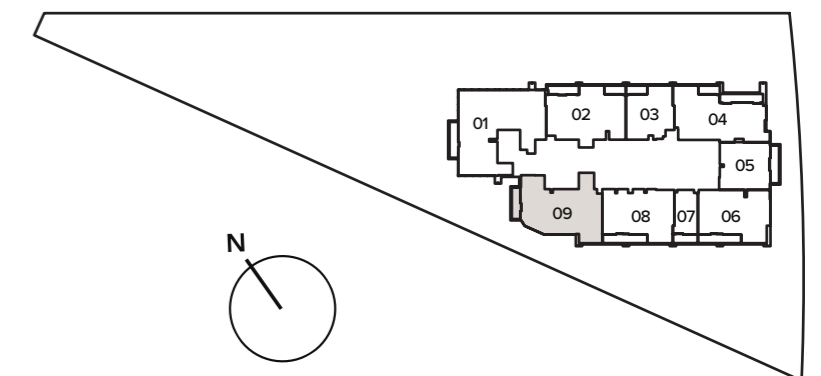

# 3 BEDROOM

TYPE A

Internal Living Area : 2276.24 Sq. Ft  
Outdoor Living Area : 121.09 Sq. Ft  
Total Living Area : 2397.34 Sq. Ft

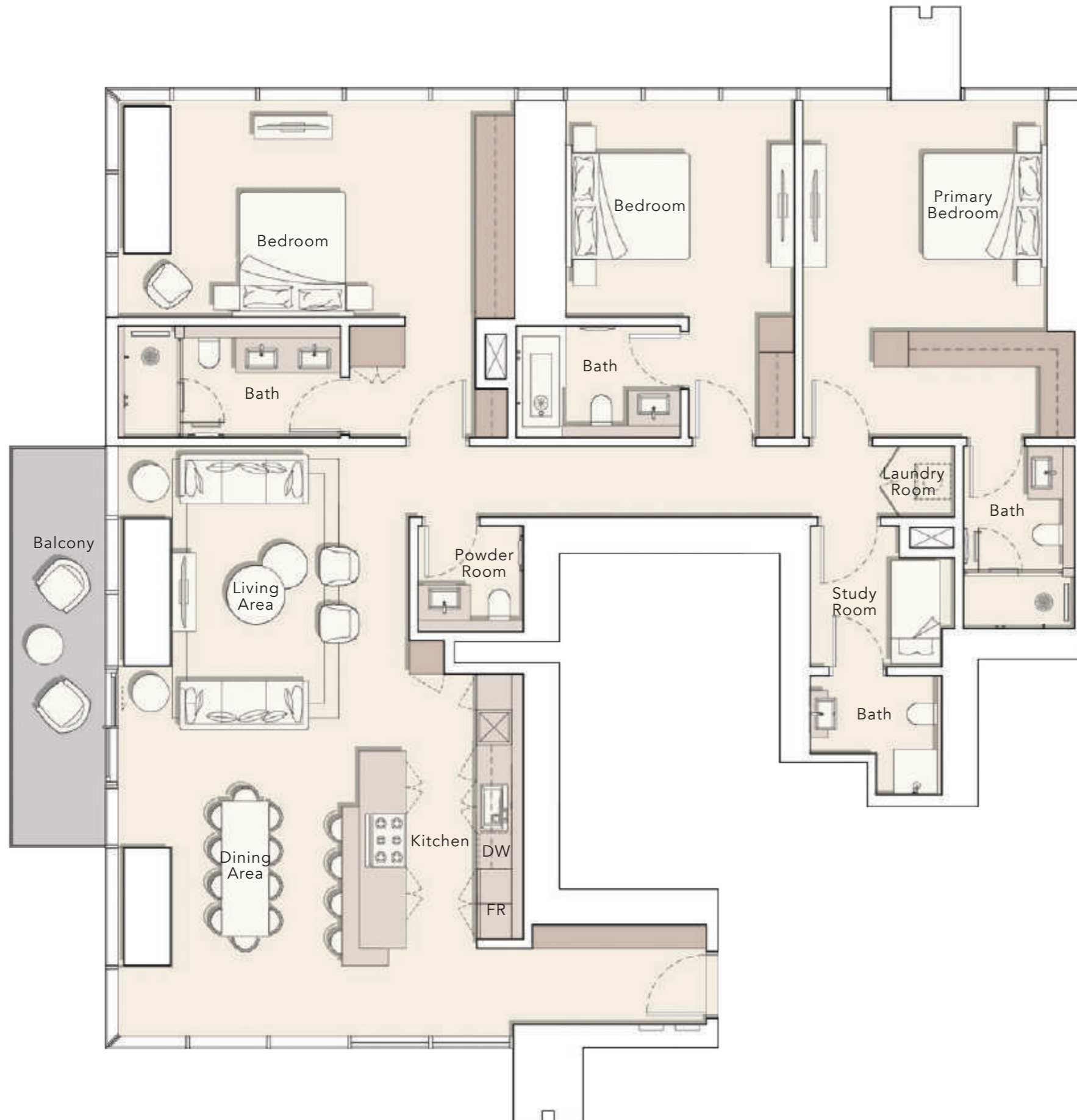

8<sup>th</sup> - 16<sup>th</sup> FLOOR

801

18<sup>th</sup> - 36<sup>th</sup> FLOOR

1801

8<sup>th</sup> - 16<sup>th</sup> FLOOR

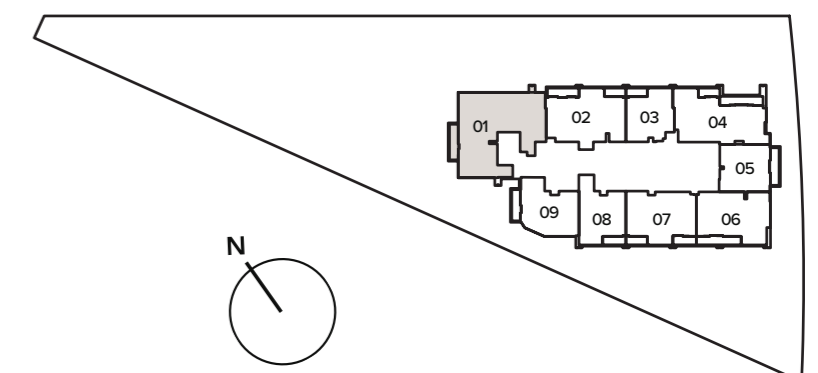

P R E M I U M  
A P A R T M E N T S



# 3 BEDROOM DUPLEX

TYPE A

Internal Living Area : 3007.22 Sq. Ft

Outdoor Living Area : 707.30 Sq. Ft

Total Living Area : 3714.52 Sq. Ft

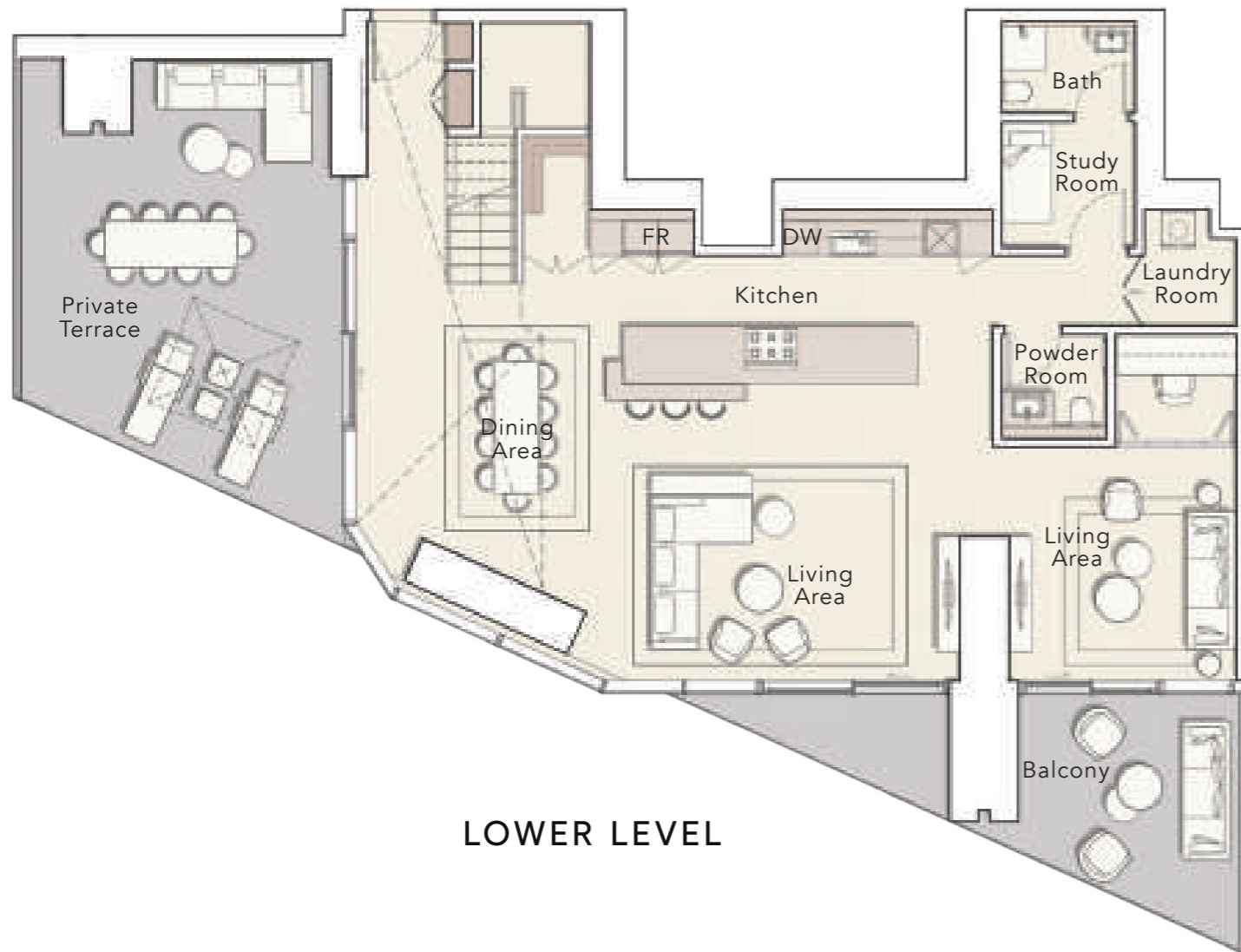

LOWER LEVEL

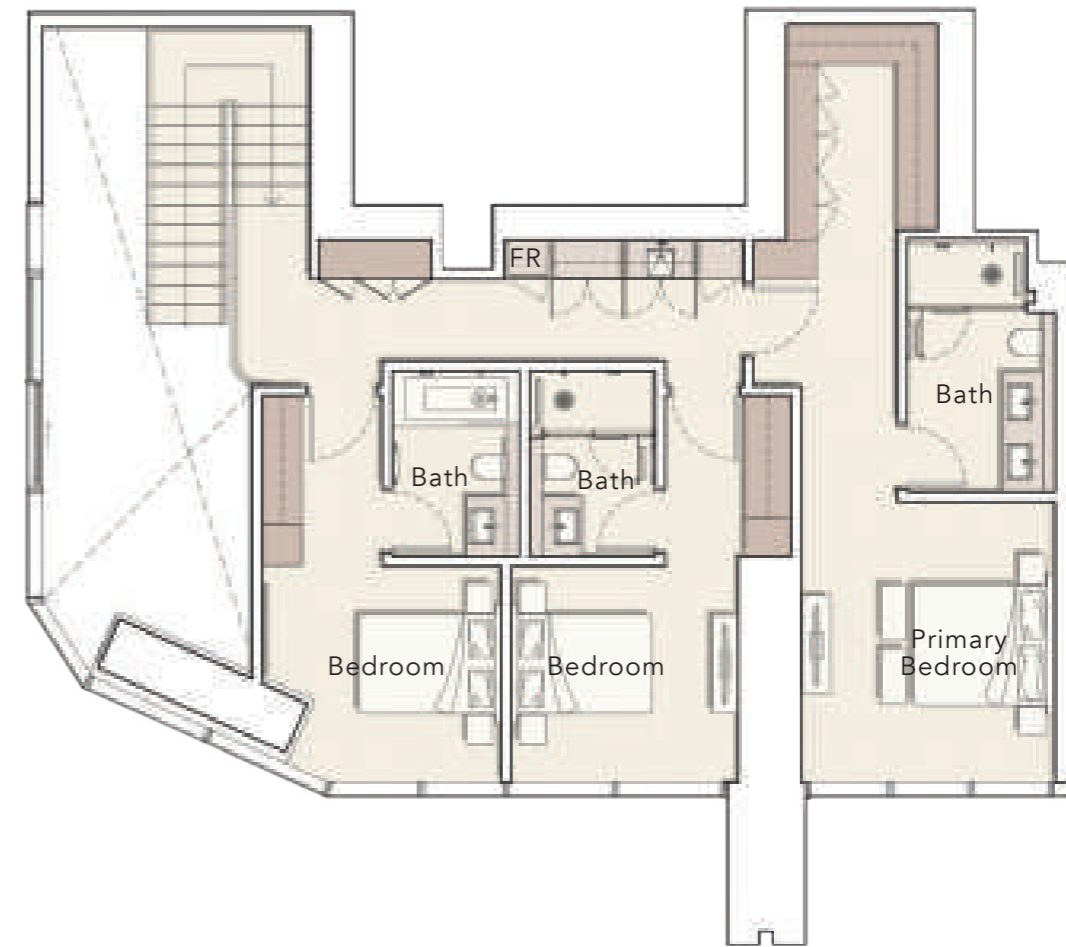

UPPER LEVEL

1<sup>st</sup> FLOOR

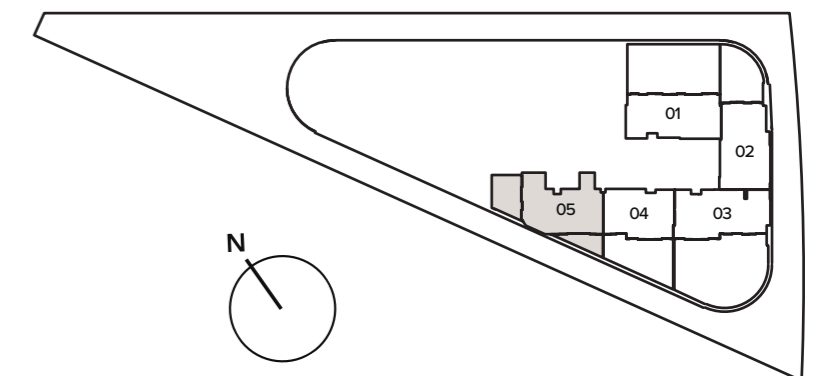

# 3 BEDROOM DUPLEX

TYPE B

Internal Living Area : 2468.49 Sq. Ft

Outdoor Living Area : 993.62 Sq. Ft

Total Living Area : 3462.10 Sq. Ft

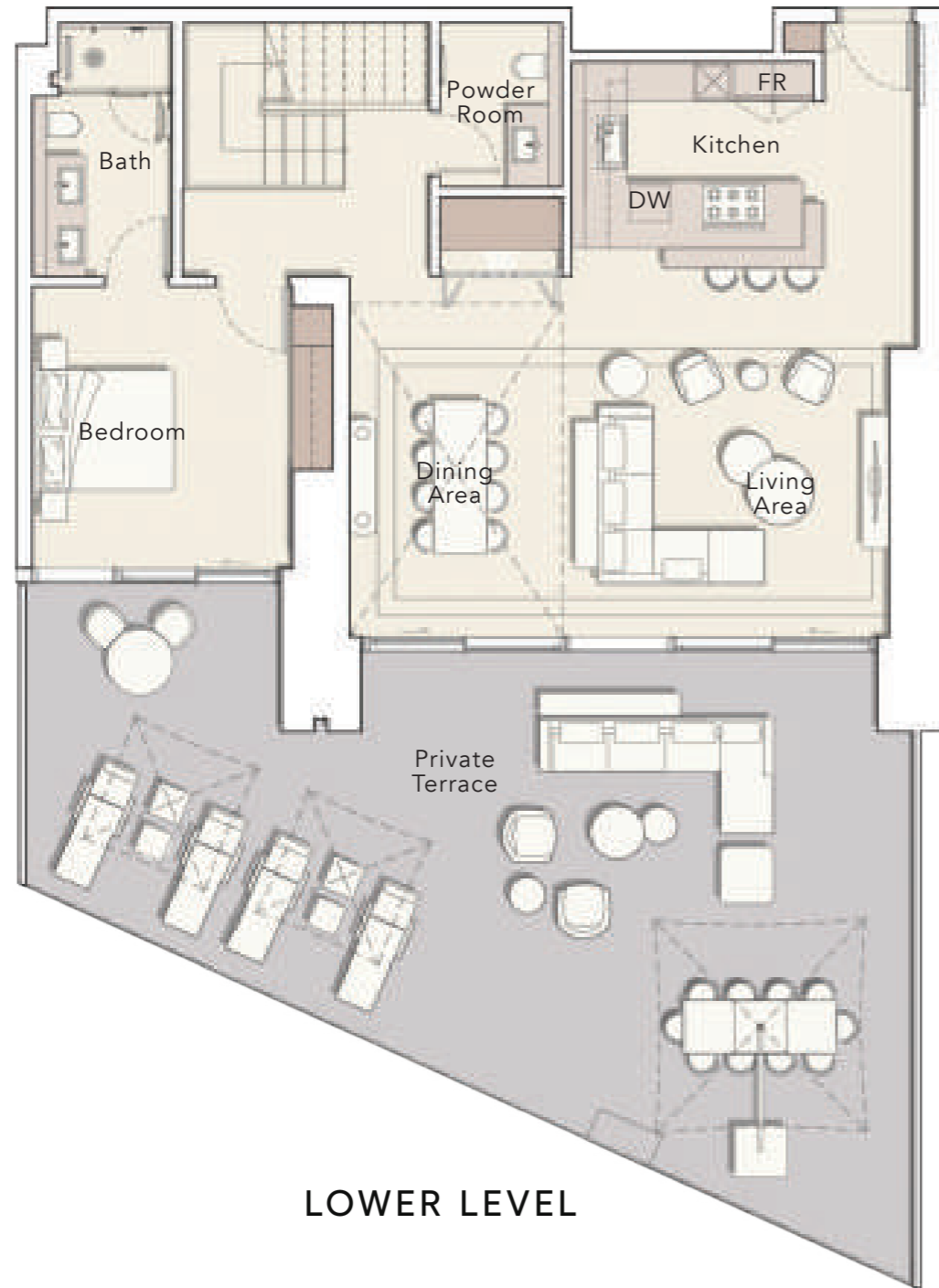

LOWER LEVEL

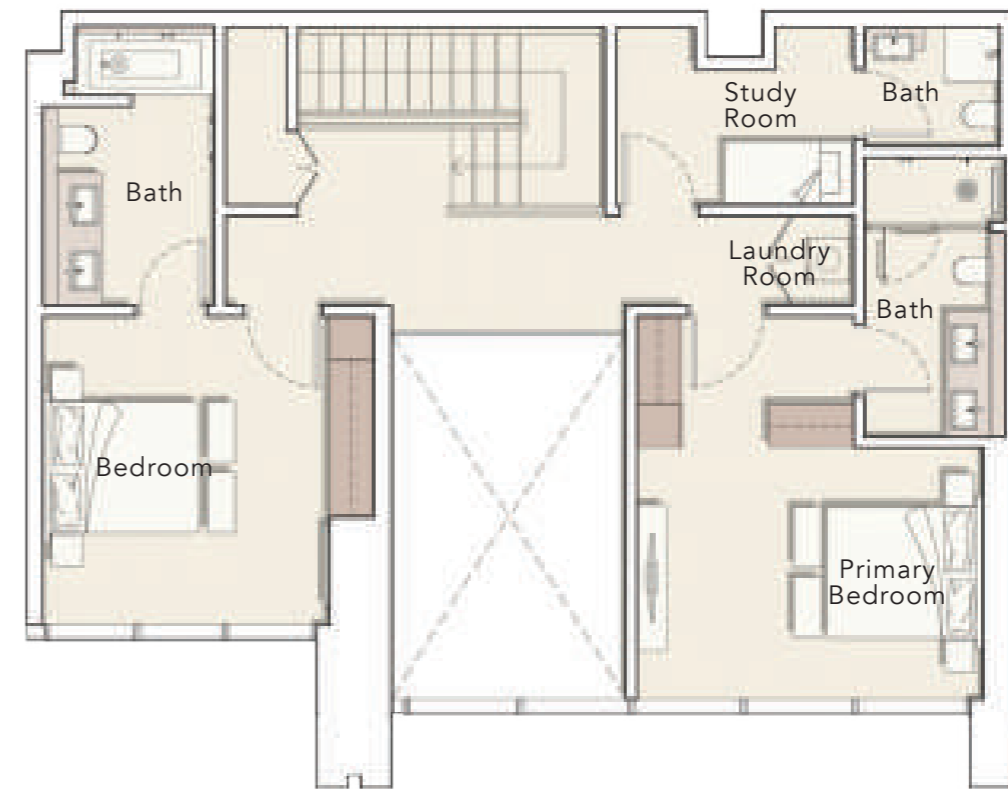

UPPER LEVEL

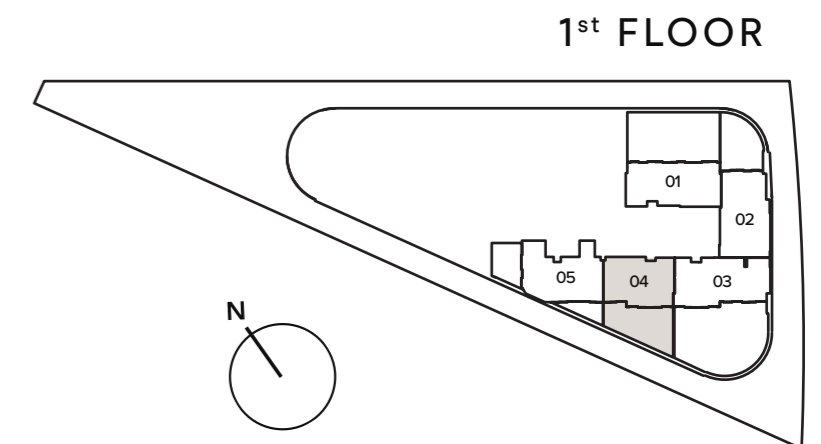

1<sup>st</sup> FLOOR

# 3 BEDROOM DUPLEX

TYPE C

Internal Living Area : 3125.73 Sq. Ft  
Outdoor Living Area : 842.92 Sq. Ft  
Total Living Area : 3968.65 Sq. Ft

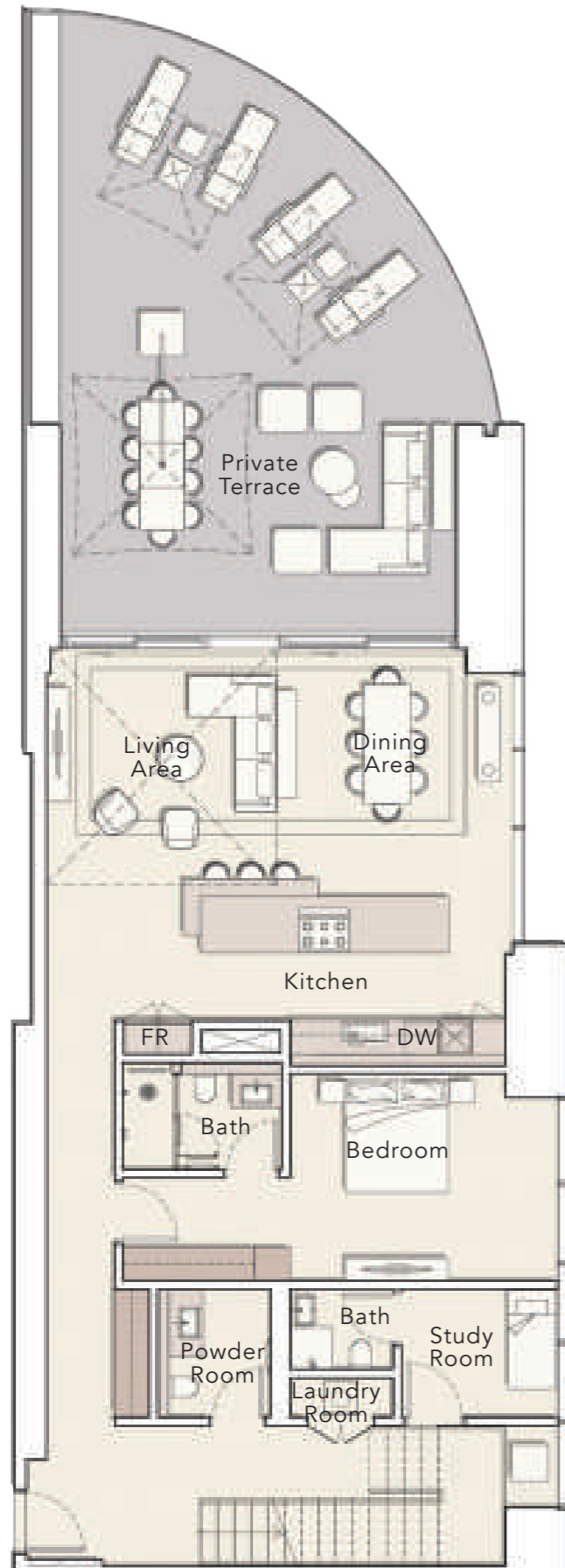

LOWER LEVEL

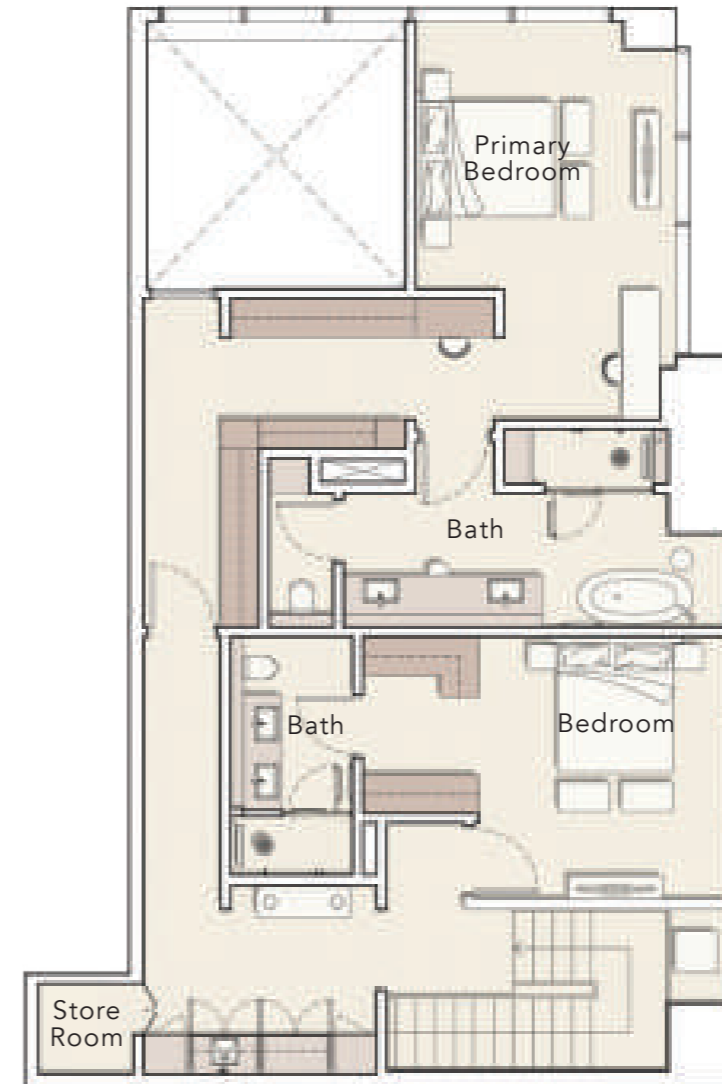

UPPER LEVEL

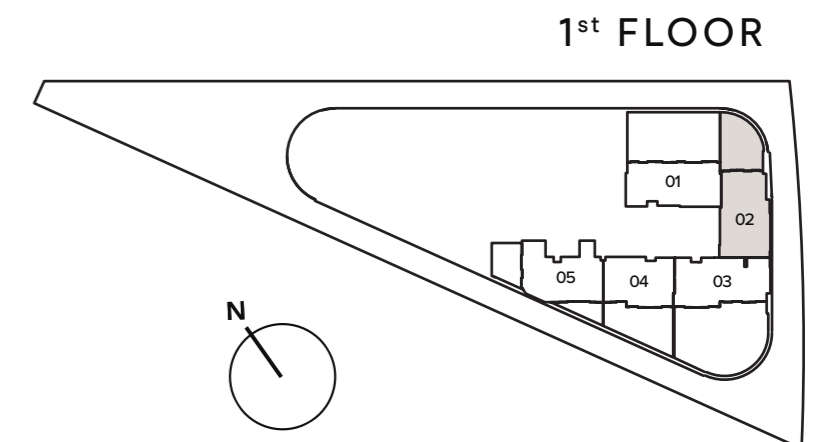

1<sup>st</sup> FLOOR

# 4 BEDROOM DUPLEX

TYPE A

Internal Living Area : 3128.96 Sq. Ft

Outdoor Living Area : 1842.89 Sq. Ft

Total Living Area : 4971.85 Sq. Ft

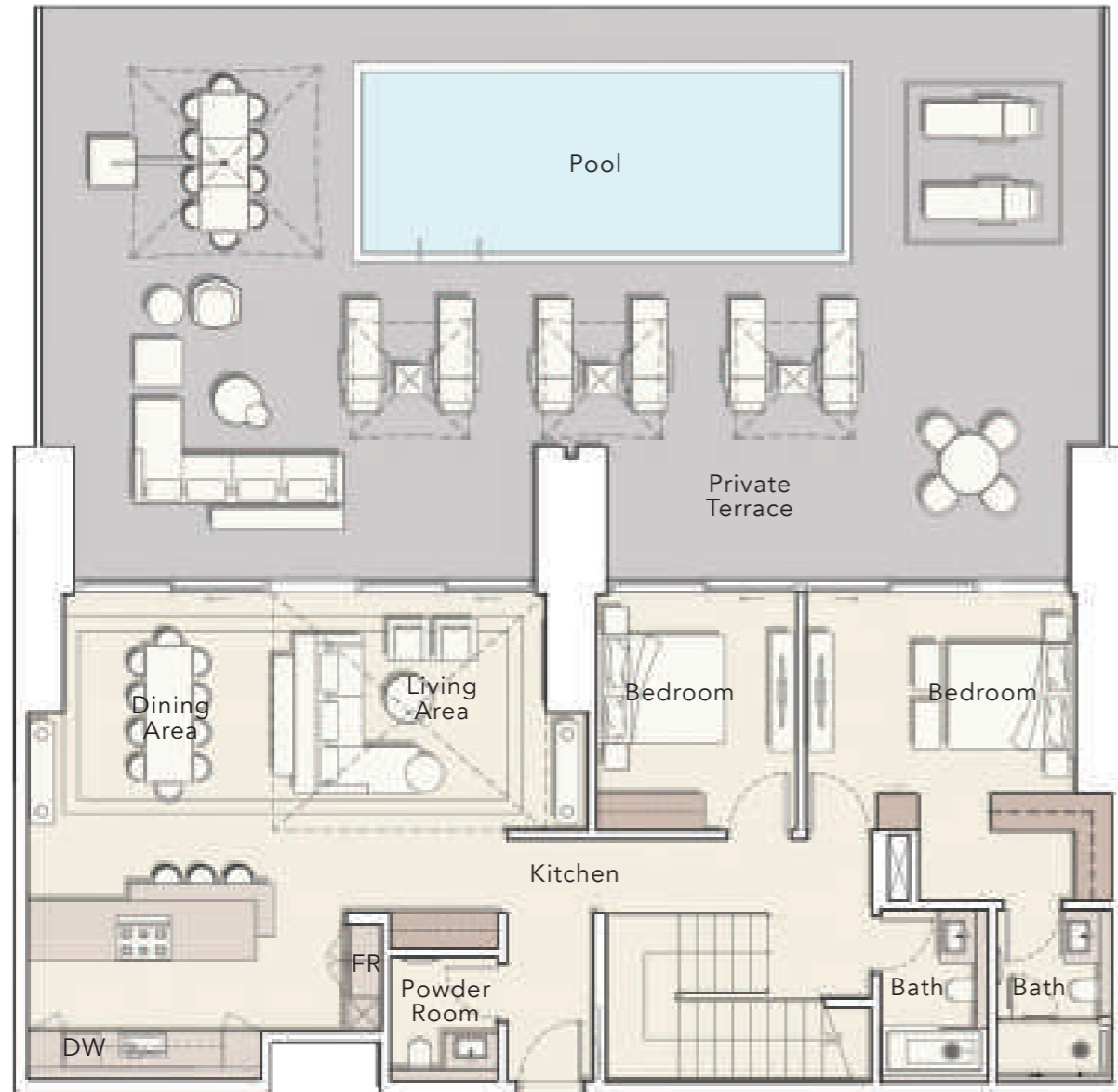

LOWER LEVEL



UPPER LEVEL

1<sup>st</sup> FLOOR

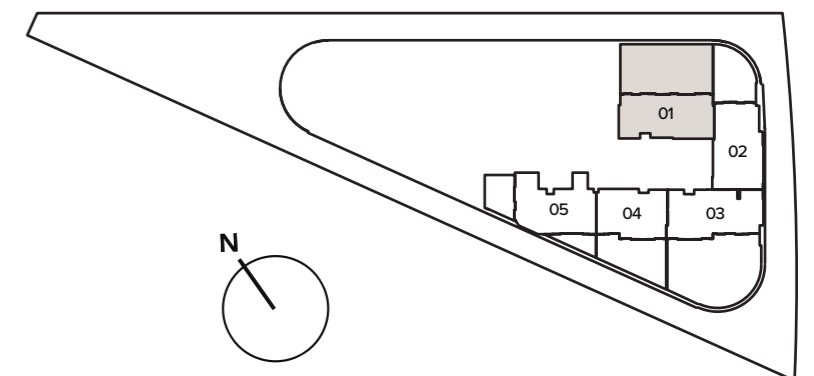

# 4 BEDROOM DUPLEX

TYPE B

Internal Living Area : 3246.50 Sq. Ft

Outdoor Living Area : 2329.74 Sq. Ft

Total Living Area : 5576.24 Sq. Ft

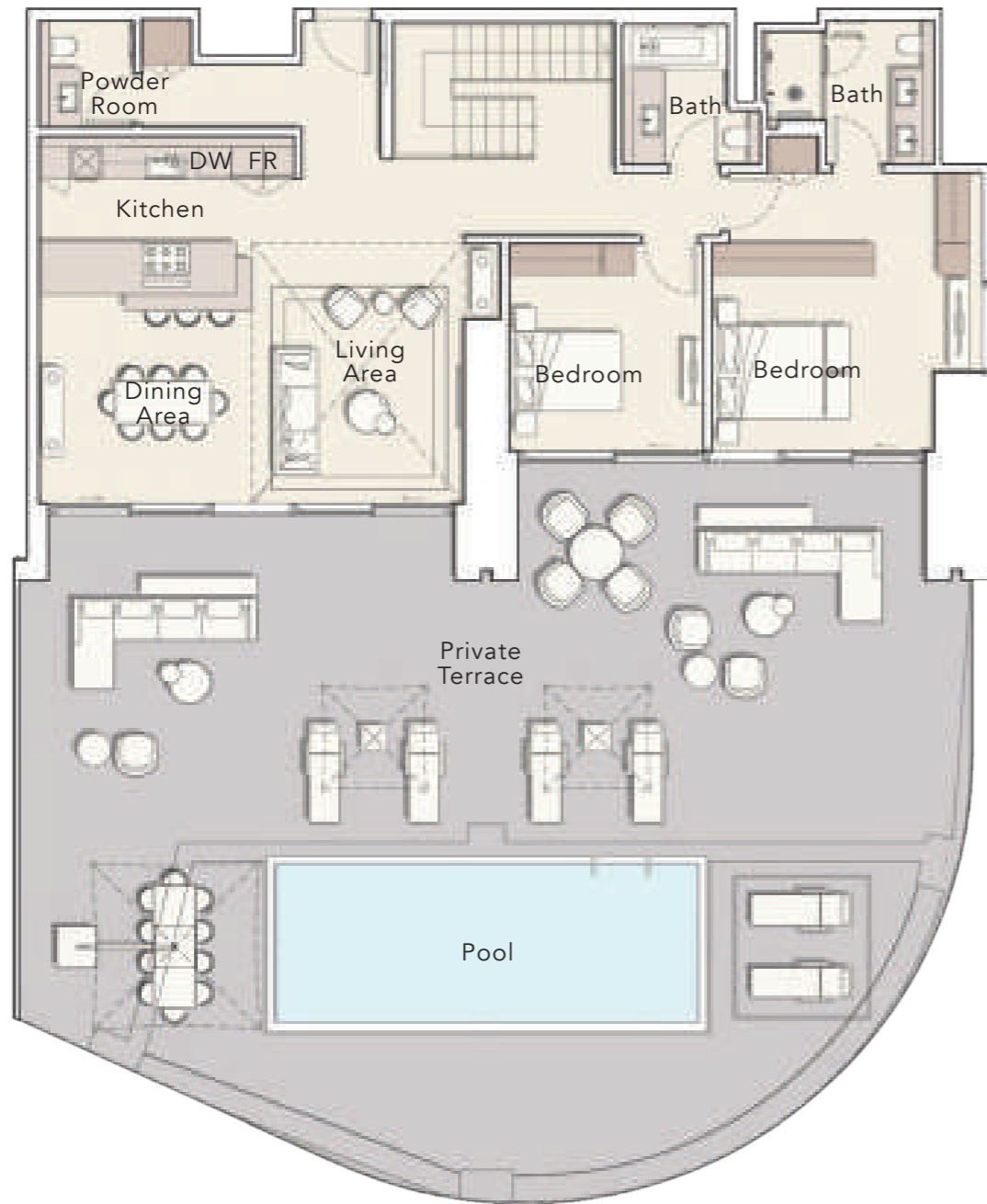

LOWER LEVEL

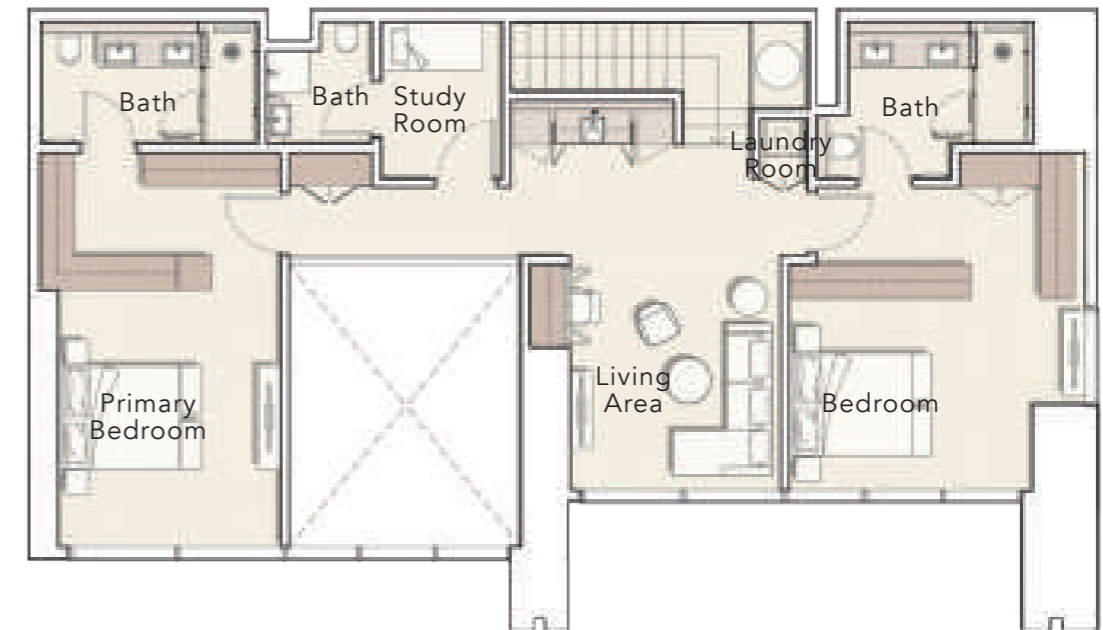

UPPER LEVEL

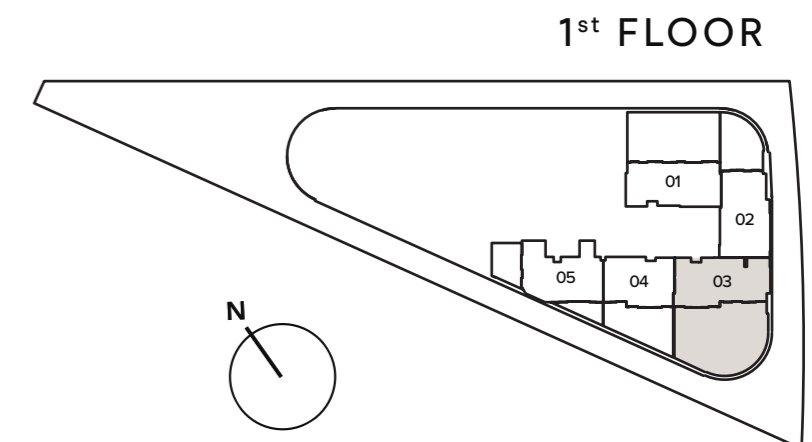

# PENTHOUSE

TYPE A

Internal Living Area : 3398.92 Sq. Ft

Outdoor Living Area : 2448.57 Sq. Ft

Total Living Area : 5847.49 Sq. Ft

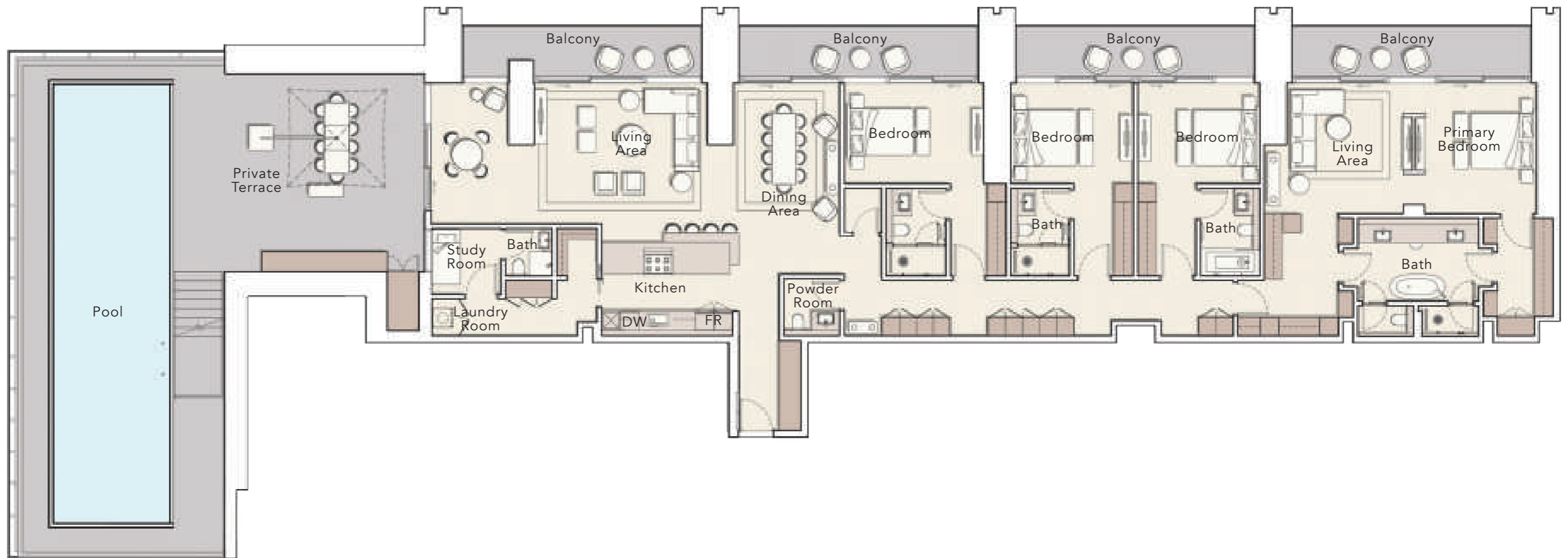

37<sup>th</sup> FLOOR

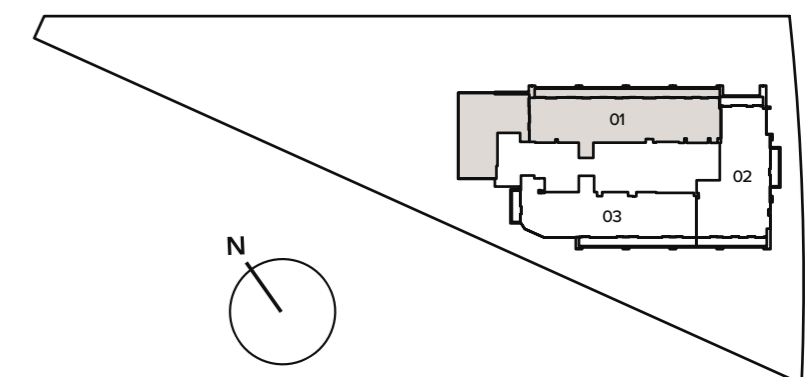

# PENTHOUSE

TYPE B

Internal Living Area : 3221.42 Sq. Ft  
Outdoor Living Area : 513.22 Sq. Ft  
Total Living Area : 3734.65 Sq. Ft

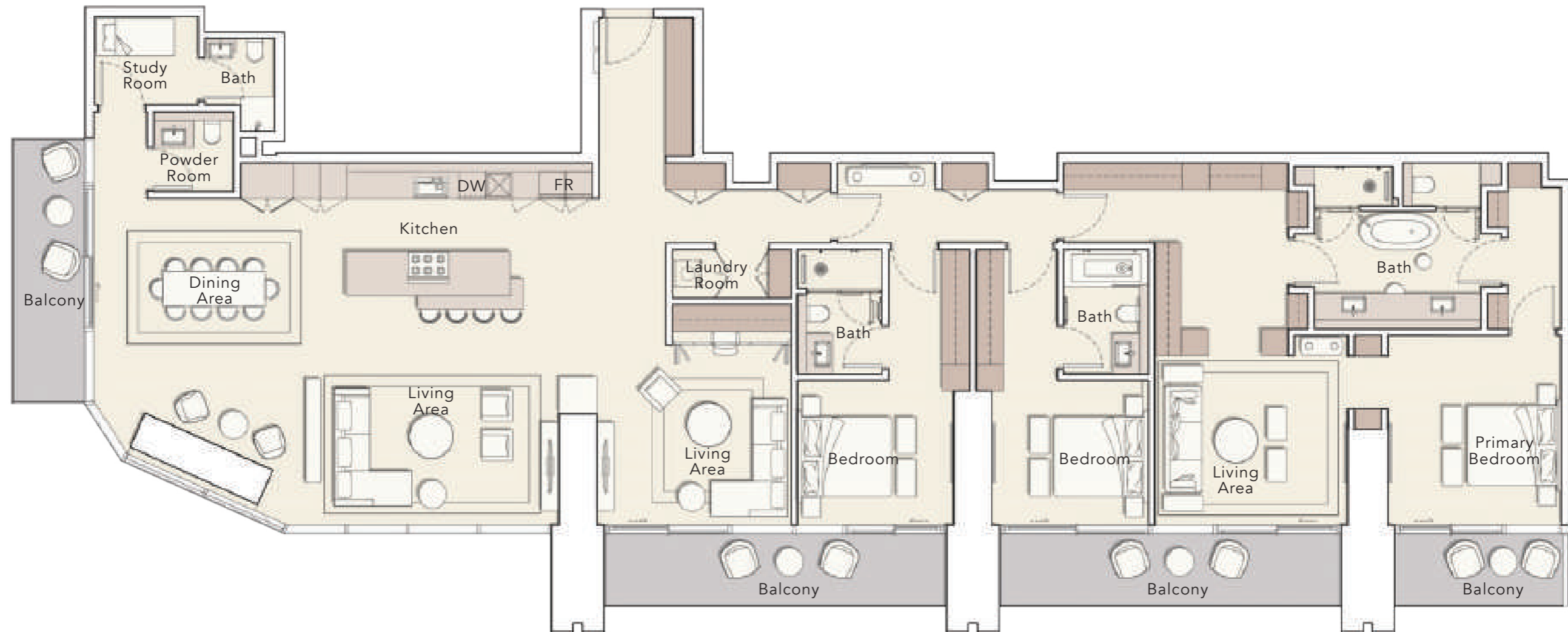

37<sup>th</sup> FLOOR

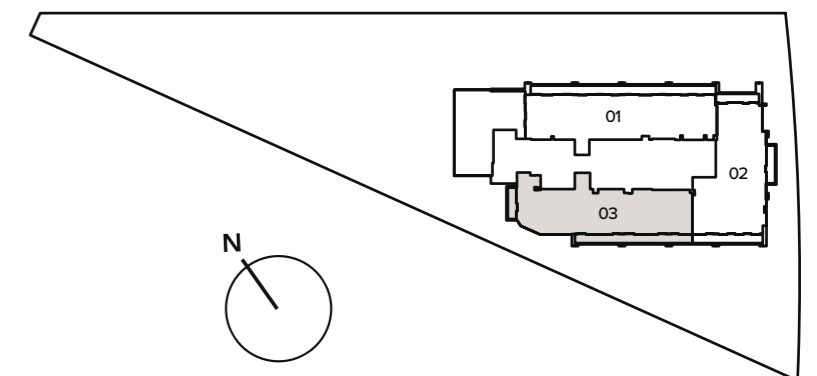

# PENTHOUSE

TYPE C

Internal Living Area : 2980.96 Sq. Ft

Outdoor Living Area : 521.83 Sq. Ft

Total Living Area : 3502.79 Sq. Ft

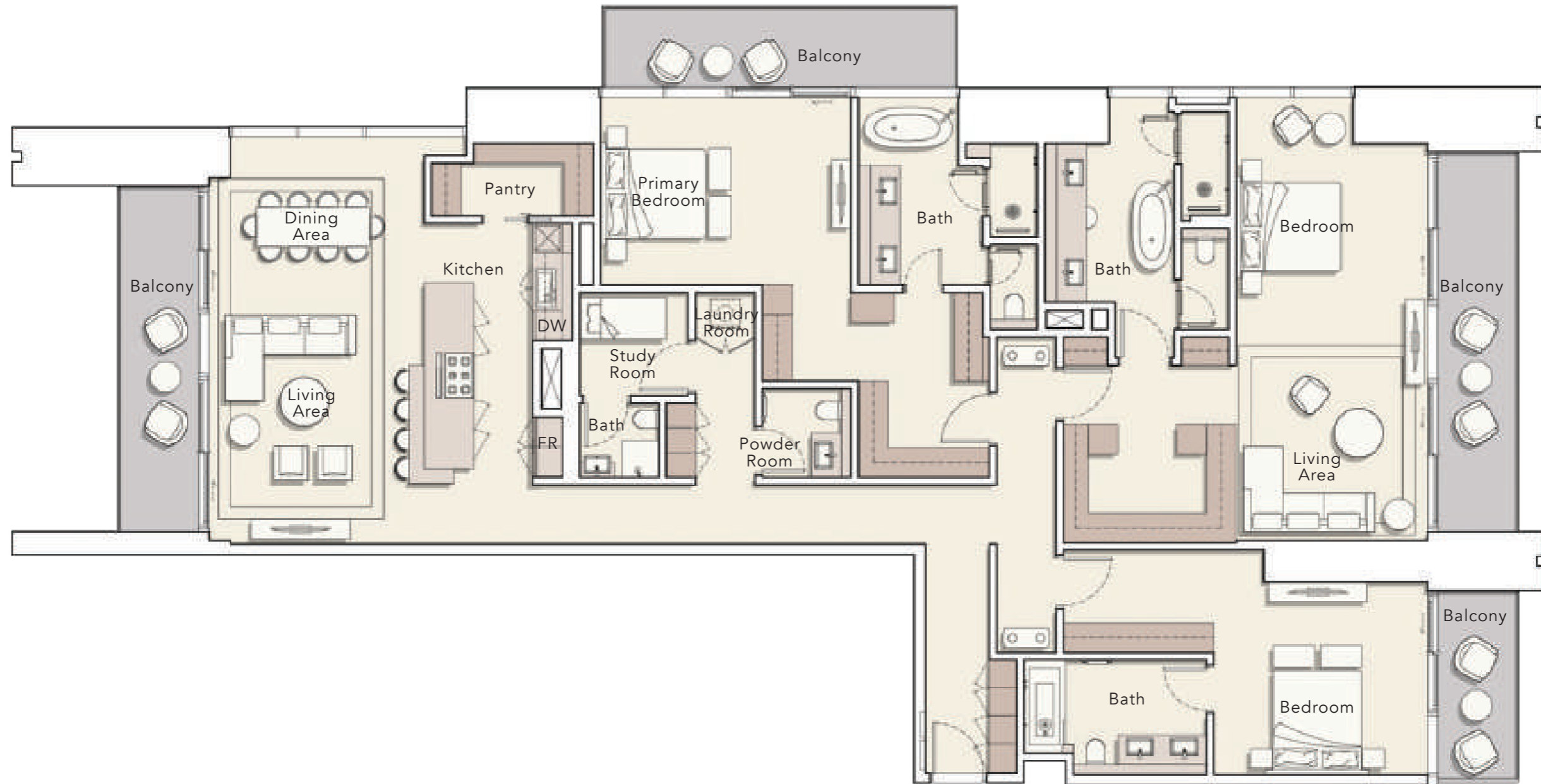

37<sup>th</sup> FLOOR

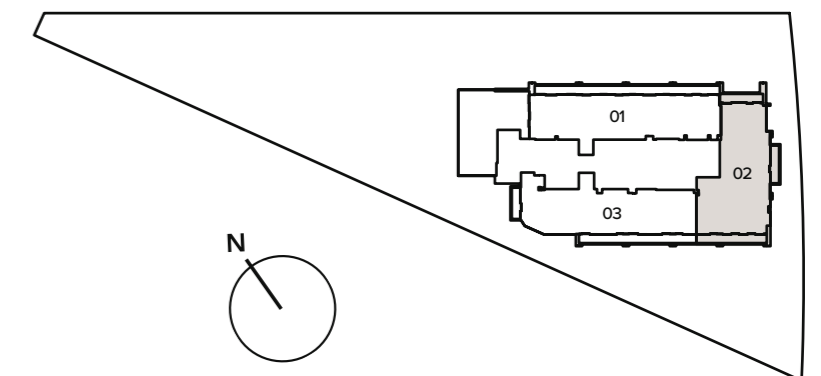



 ELLINGTON | **DUTCO**